

H.323, Megaco/H.248 and Soft-Switches

INSE 7110 – Winter 2006

Value Added Services Engineering in Next Generation Networks

Week #5

Outline

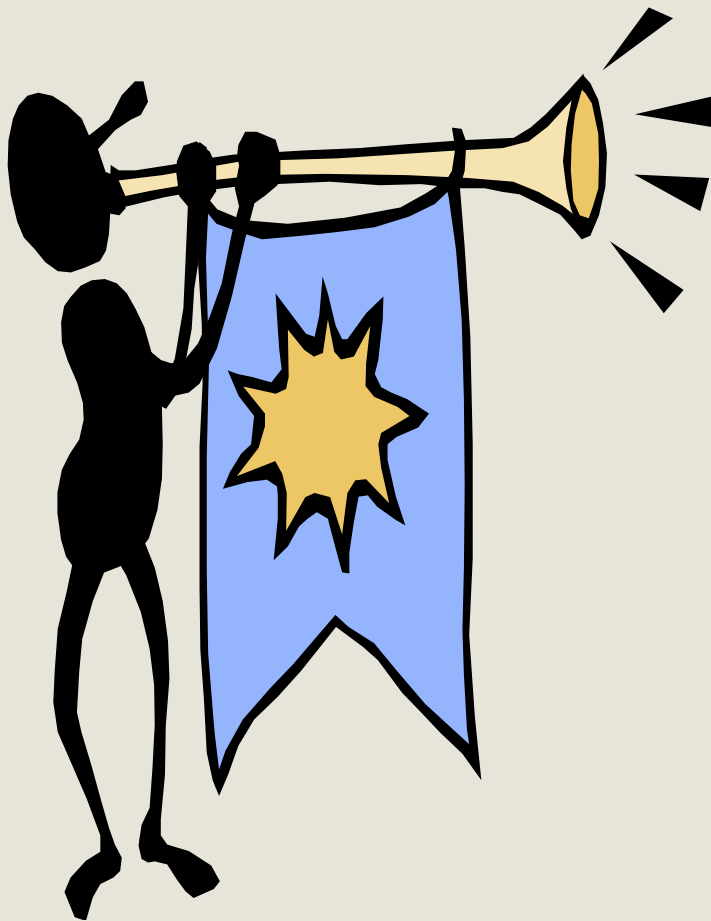

1. H.323
2. Megaco/H.248
3. Soft-switches

H.323

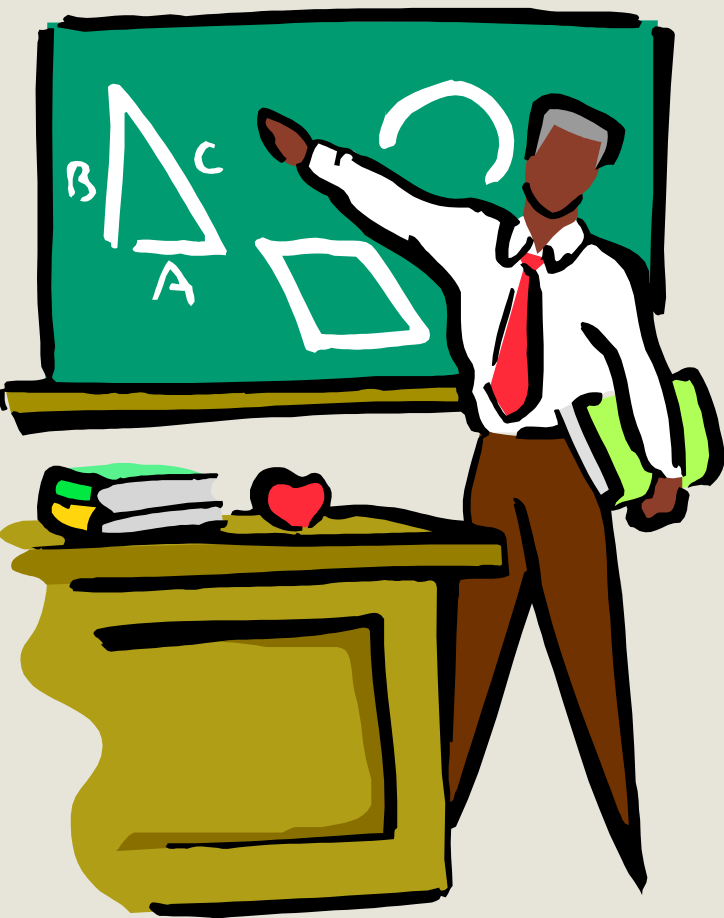

1. Introduction
2. Functional entities
3. Signaling protocols
4. H.323 vs. SIP

H.323: Introduction

An umbrella ITU-T standard including

- signalling standards:
 - H.225.0
 - Q.931
 - H.245
- Others (e.g. H.324 Terminal for low bit rate multimedia communications)

H.323: The functionality entities

Terminals

- End point
- Used for real time two way multimedia communications with another end point

Gatekeeper

- Control how terminal access networks
- Provide address translation

Gateway

- End point
- Used for communications between H.323 terminals and terminals in the PSTN

Multipoint control unit (MCU)

- Provides centralized conferencing functionality

H.323 signaling: Registration Admission and Status (RAS)

Key features

- ASN.1 based messages
- Request / reply protocol
- Signaling between end-points
 - Terminal or gateway and
 - Gatekeeper
- Use unreliable channels
 - Retries
 - Timeouts

RAS: Gatekeeper discovery ...

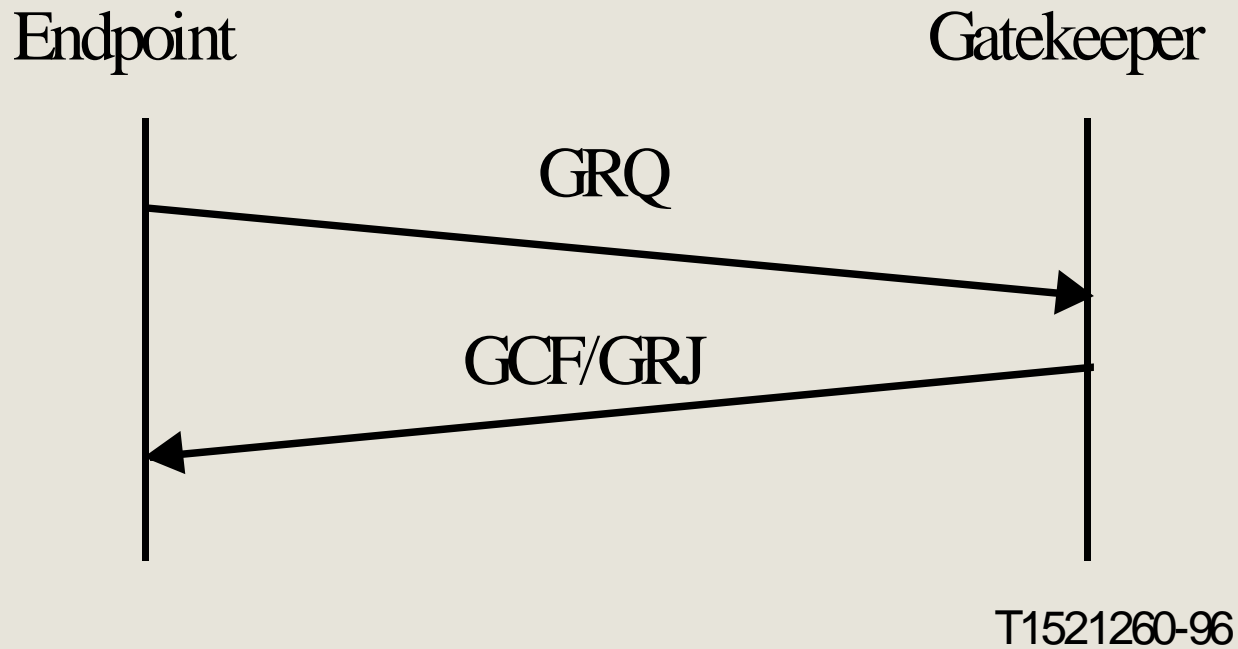

RAS: Admission request ...

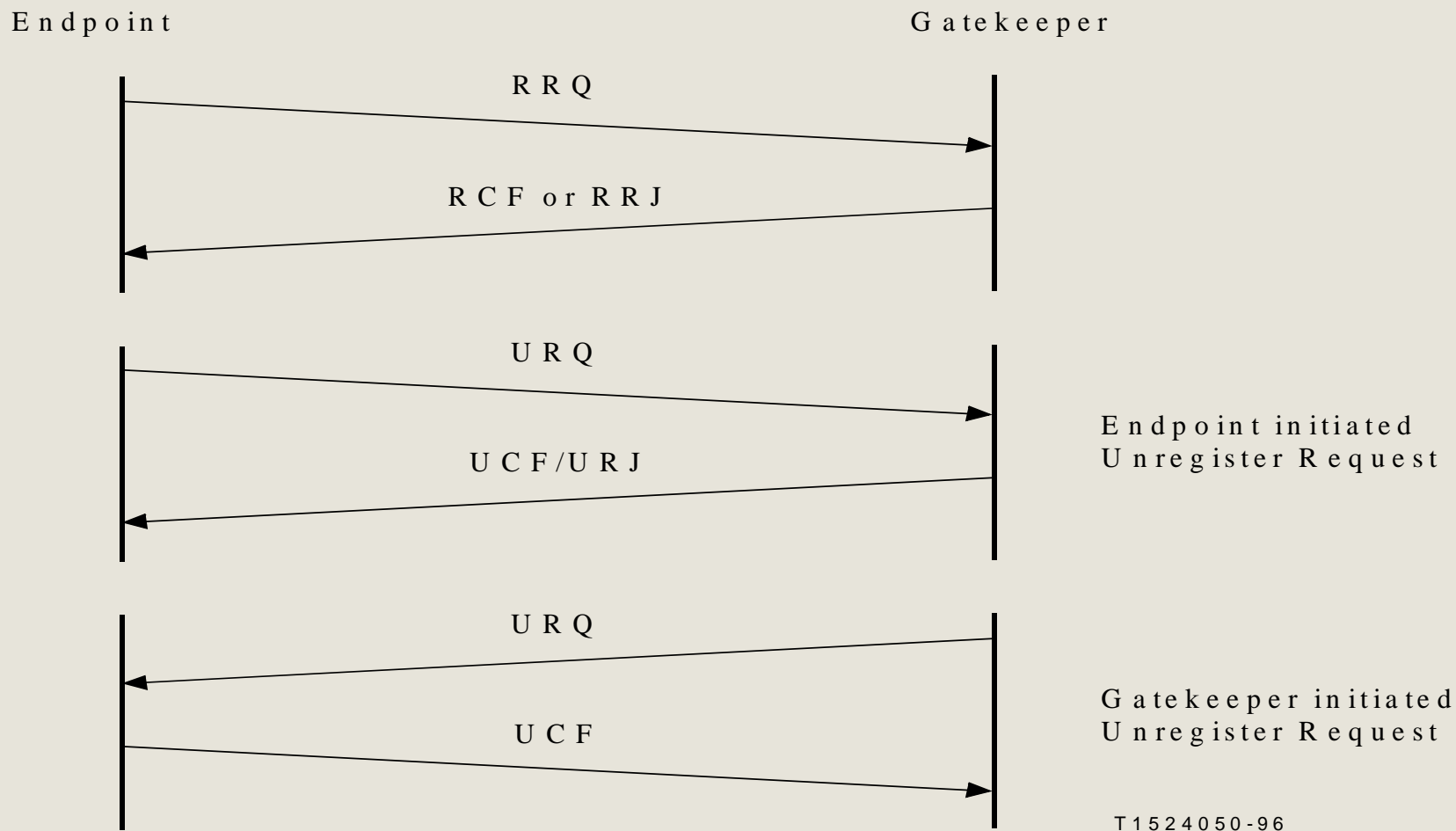

H.323 signaling: Call Set Up (H.225)

Key features

- ISUP signaling (Q.931) based
- ASN.1 based messages
- Transaction oriented protocol
- Signaling between end-points
 - Terminal or gateway
and
 - Gatekeeper
- Use reliable channels

RAS: Call set up - No gatekeeper ...

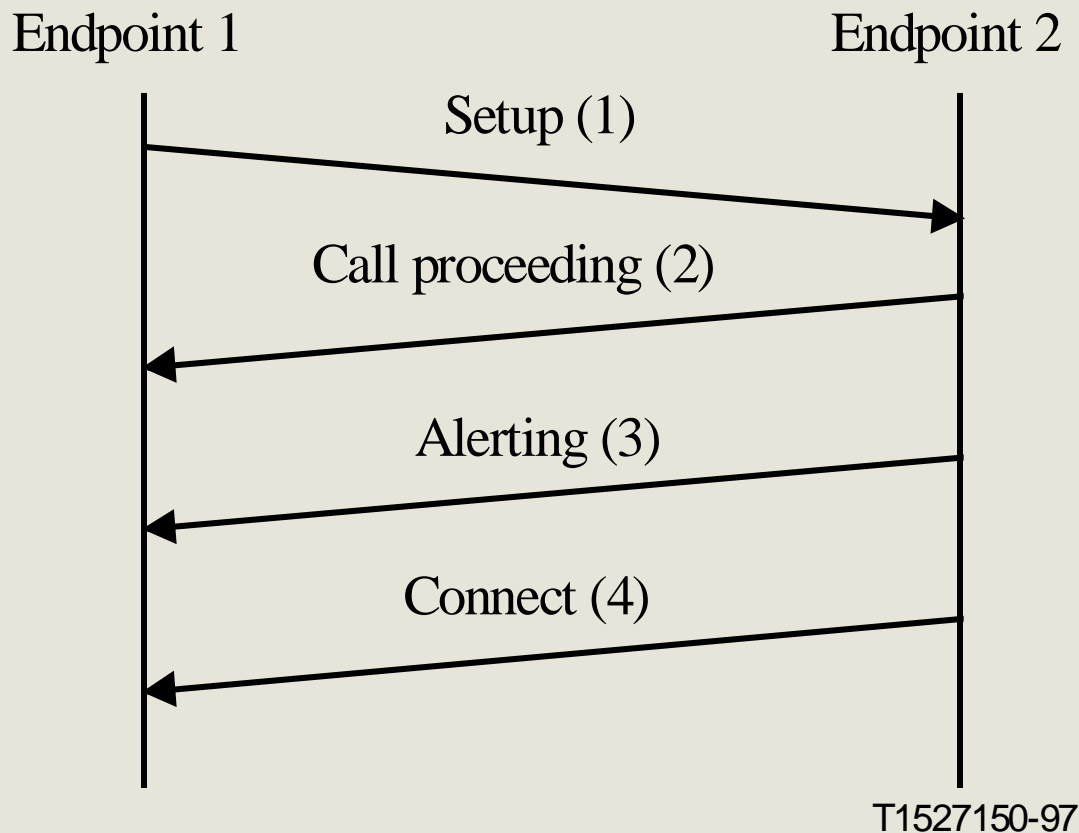

— Call Signalling Messages

RAS: Call set up - 1 gatekeeper ...

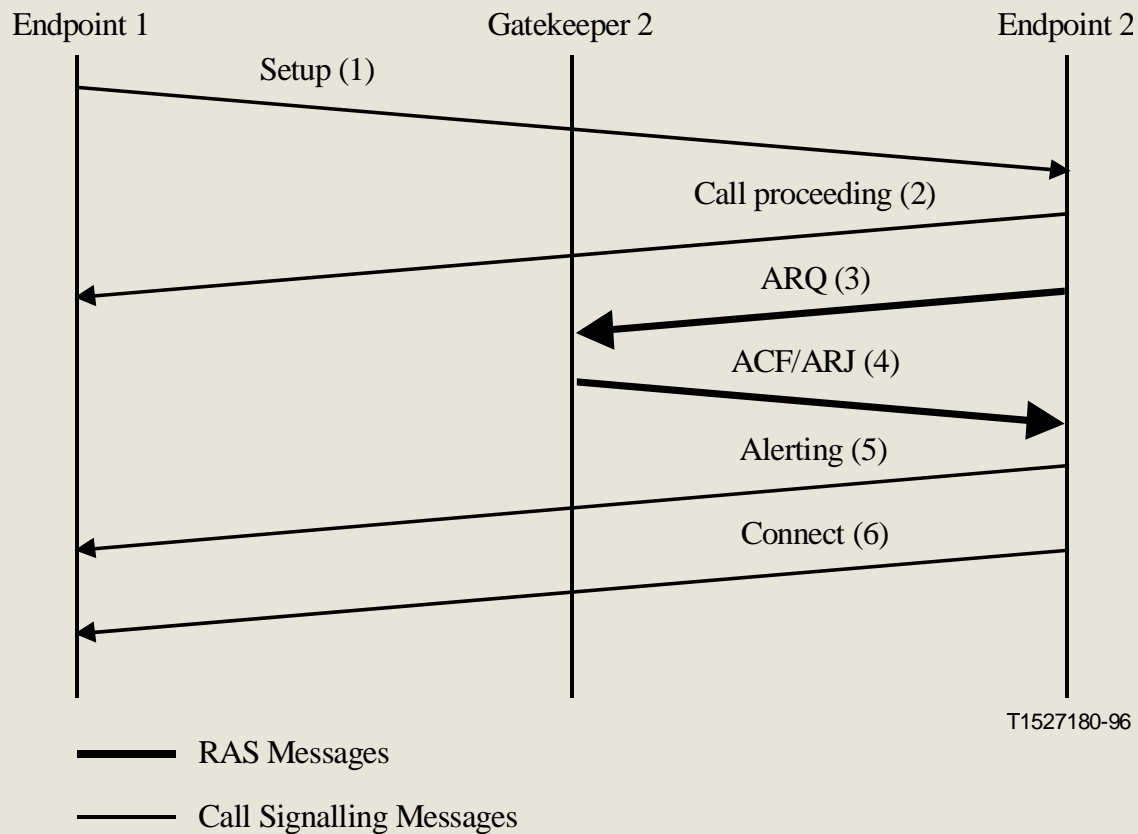

RAS: Call set up - Two gatekeepers ...

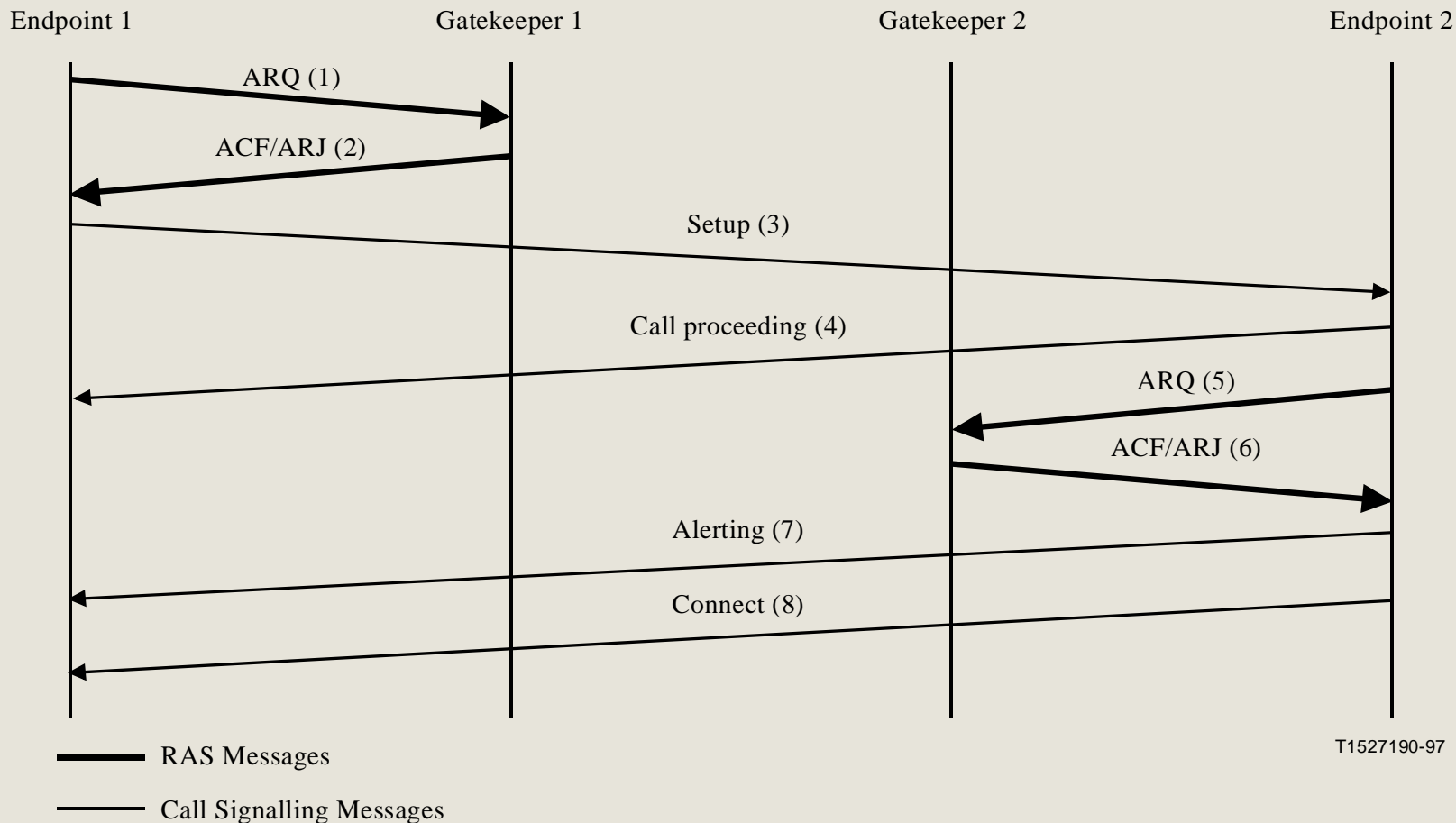

H.323 signaling: Media signaling (H.245)

Key features

- ASN.1 based messages for
 - Master/slave determination
 - Capabilities negotiation
 - Logical channel signaling
- Several modes
 - Request/reply
 - Commands
 - Indications
- Signaling between end-points
 - Terminal or gateway
and
 - Gatekeeper
- Use reliable channels

H.323 signaling: Master / slave determination

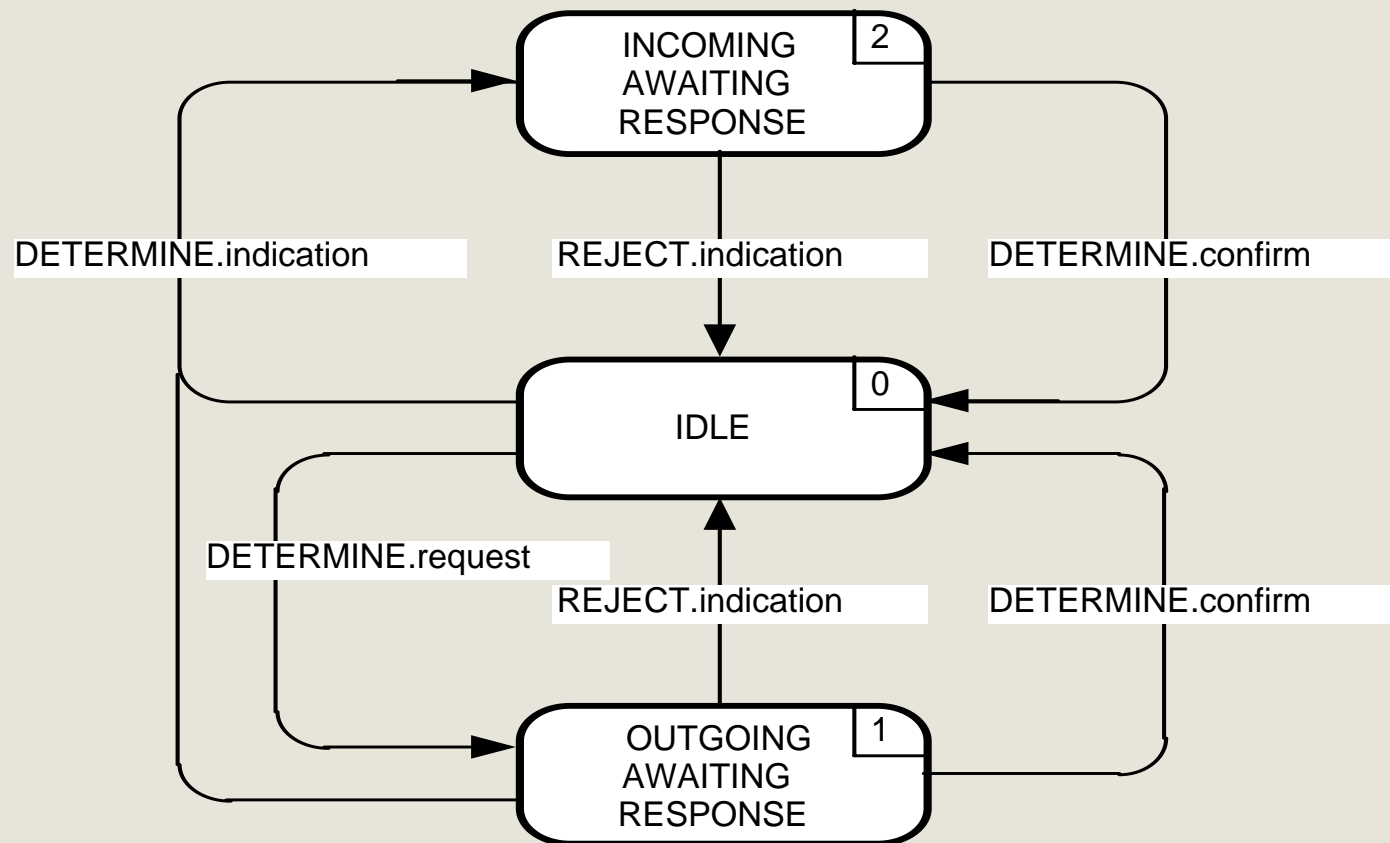

H.323 signaling: Capabilities exchange

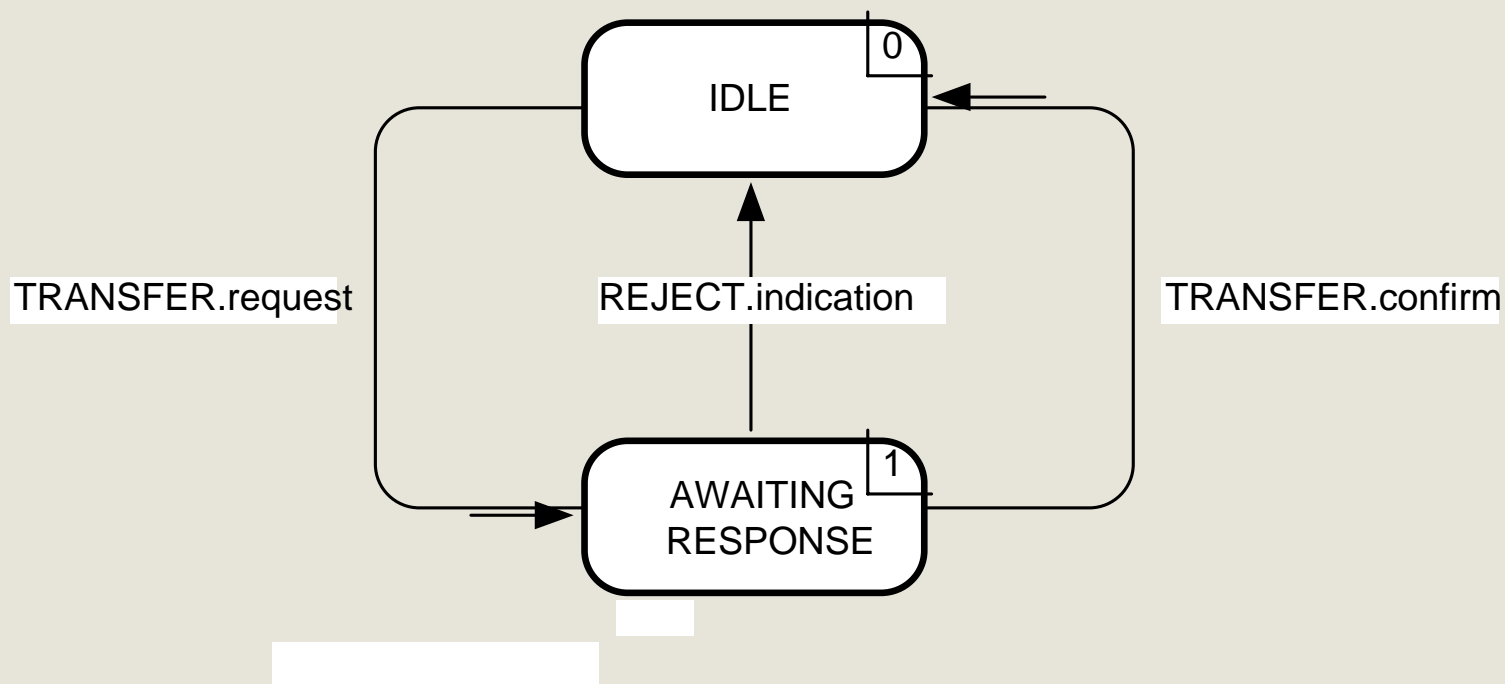

H.323 signaling: Capabilities exchange

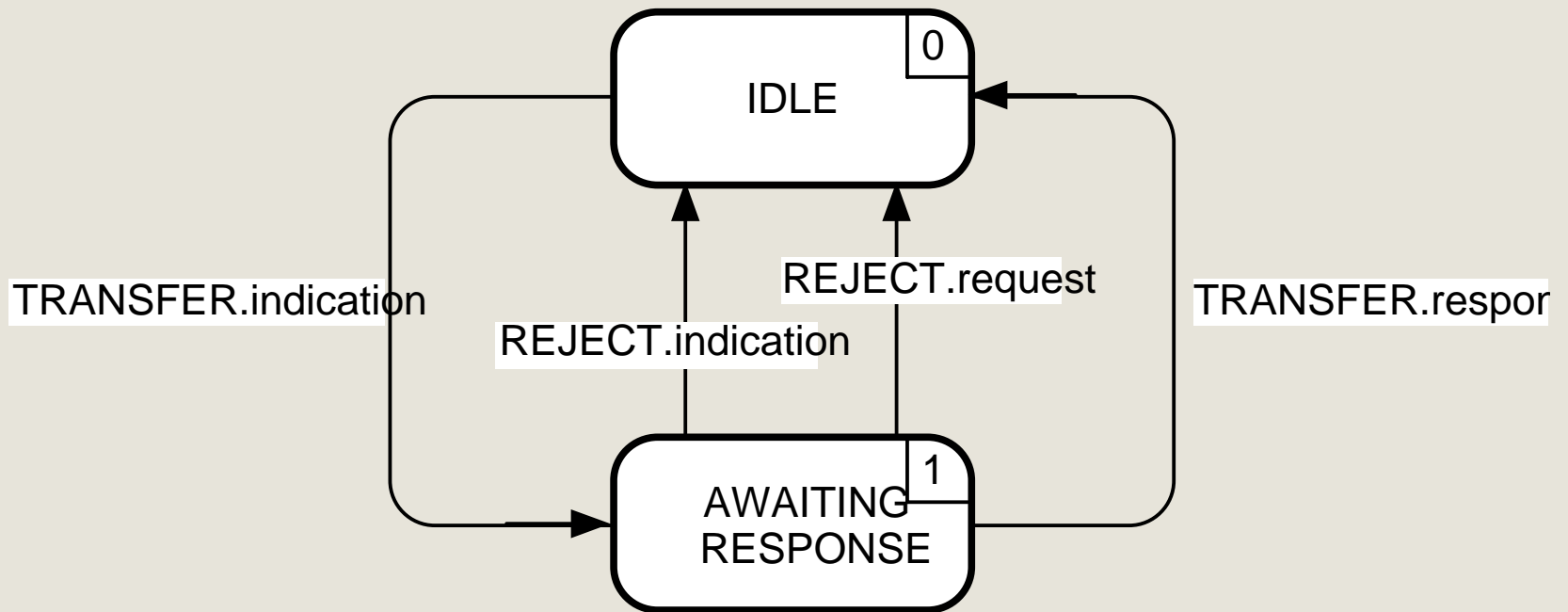

H.323 signaling: Logical channels

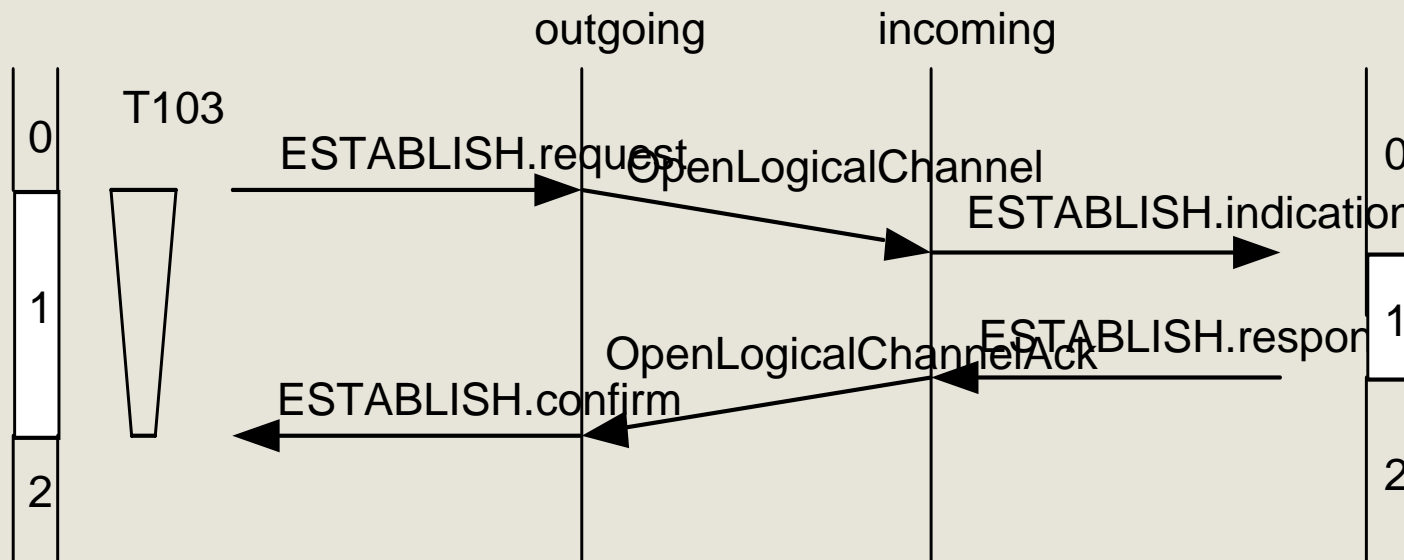

H.323 signaling: Logical channels

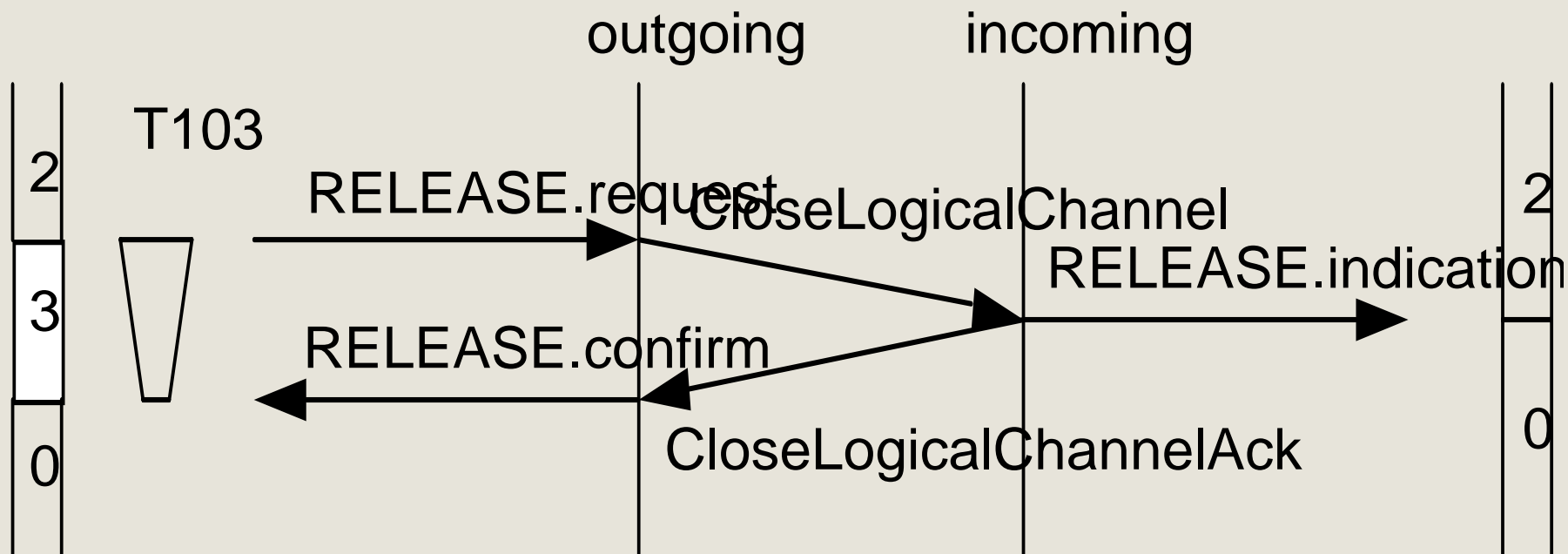

H.323 signaling: An important feature - Fast connect

Introduced as an afterthought in H.323

Allow call set up and logical channel set up using a single message

- **FASTCONNECT**

- Include as parameter fast start to indicate that logical channel should be opened
- May be refused by the other end (Fast connect refused)

H.323 signaling: Putting it together ... alternative 1

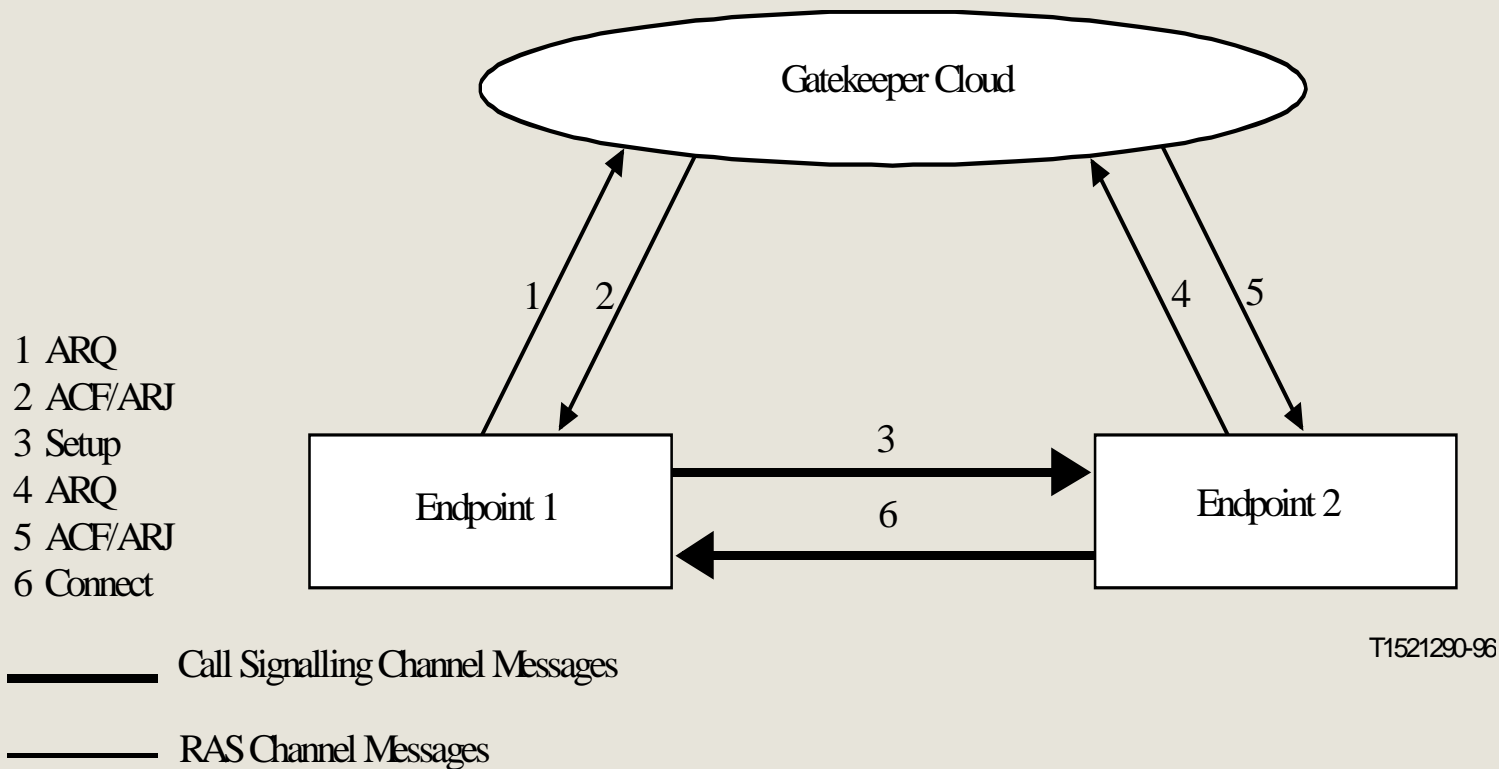

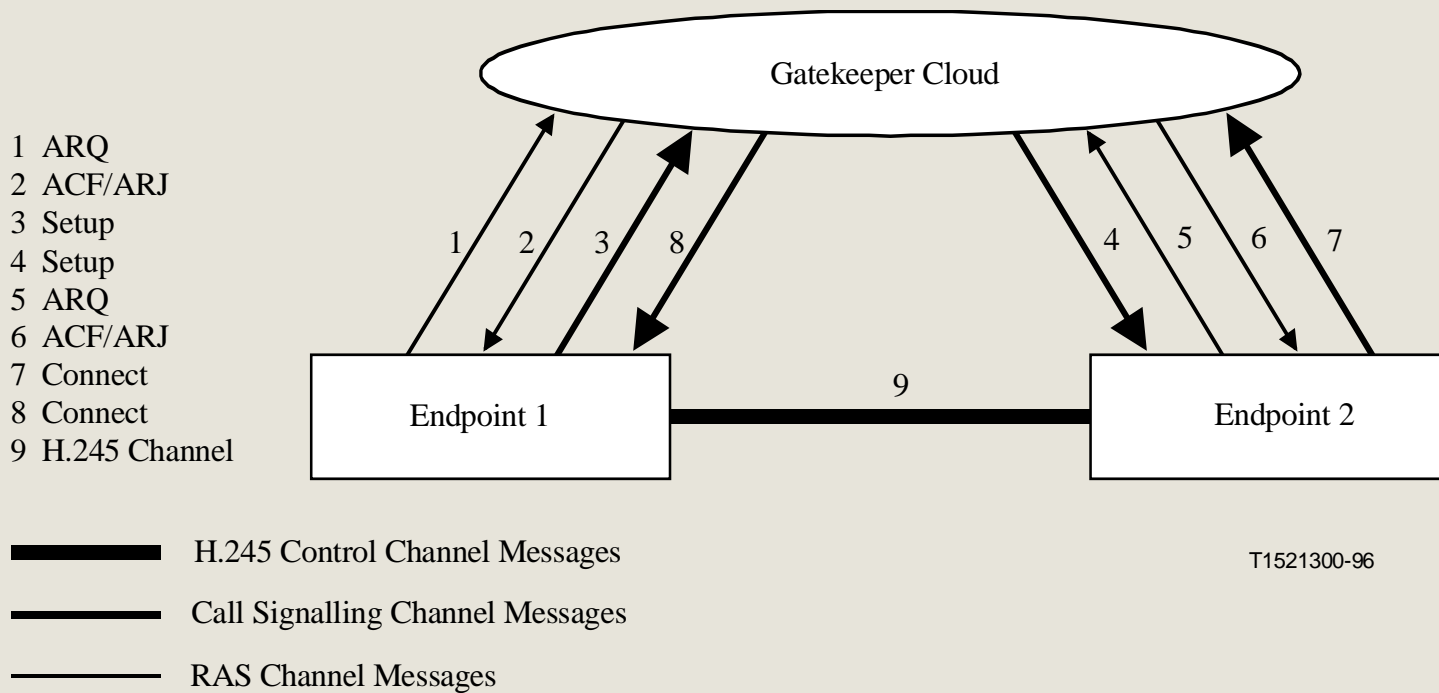

H.323 signaling : Putting it together ...alternative 2

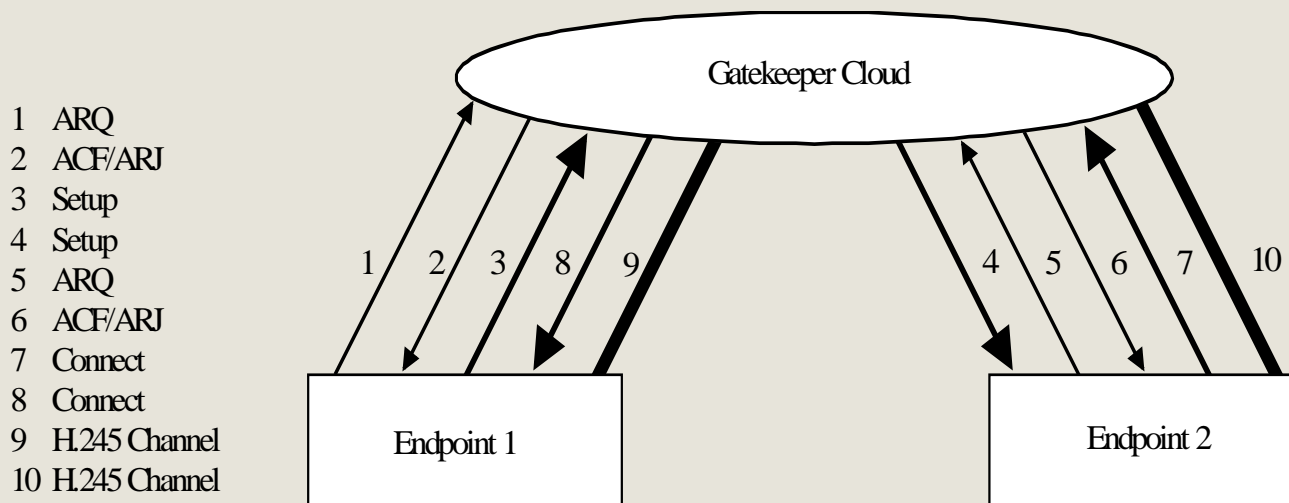

H.323 signaling: Putting it together - alternative 3

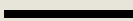

-  H.245 Control Channel Messages
-  Call Signalling Channel Messages
-  RAS Channel Messages

T1521310-96

Megaco / H.248

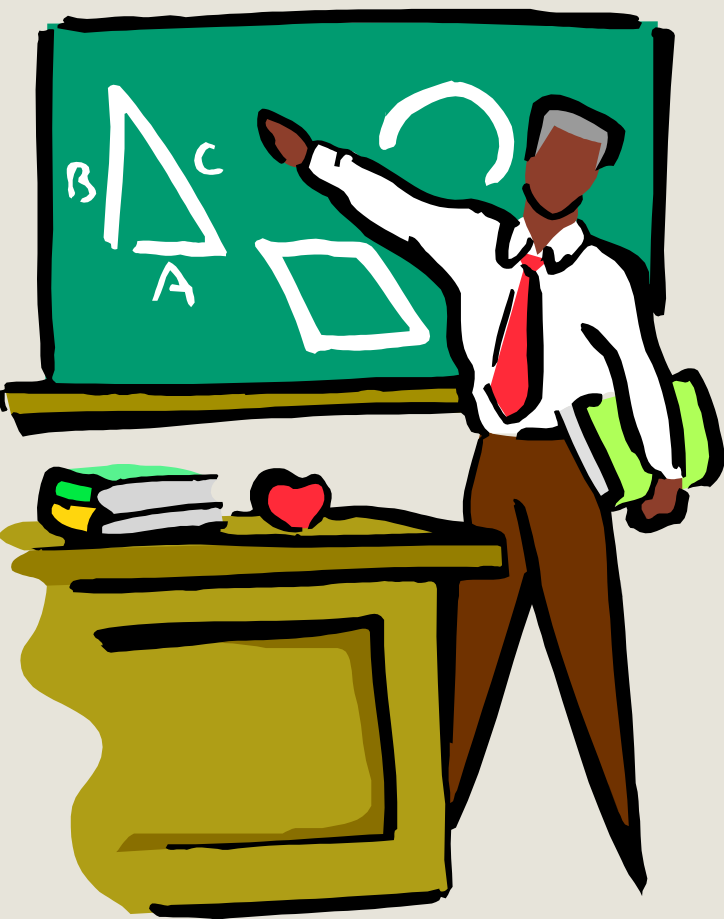

1. Introduction

2. Genesis

3. Concepts

4. Protocol

5. Call cases

Megaco/H.248: Introduction

Primary motives for decomposing gateways between PSTN and next generation networks:

- Scalability
- Specialization
- Opening up of market to new players

Side-effect

- Possibility of using the part of the decomposed gateway for call control
 - Soft-switches

Megaco/H.248 : Introduction

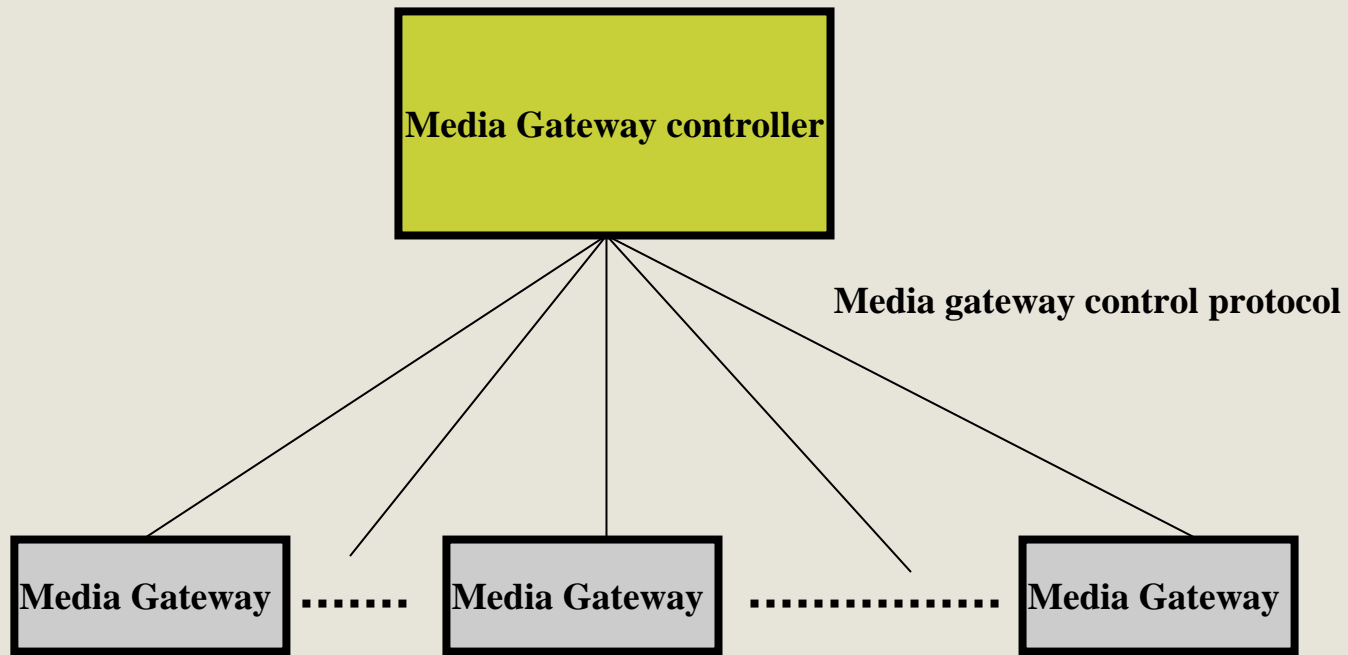

▪

Megaco/H.248: Genesis

A long history starting in 1998

- Simple Gateway Control Protocol (SGCP)
 - Text based encoding, limited command set
- IP Device Control Protocol (IPDCP)
 - A few more features to SGCP
- Media Gateway Control Protocol (MGCP)
 - Merge of SGCP and IPDC
- Media gateway Decomposition Control Protocol (MDCP)
 - Binary encoded
- Megaco / H.248 (Joint IETF / ITU-T specifications)
 - A compromise
 - Both text based and binary encoding
 - A wide range of transport protocols(e.g. UDP, TCP, SCTP)

Megaco/H.248: Concepts - Termination

Source or sink of media

- Persistent (circuit switched) or ephemeral (e.g. RTP)
- IDs
 - Unique or wildcard mechanism (ALL or CHOOSE)
- Properties/descriptors
 - Unique ids
 - Default values
 - Categorization
 - Common (I.e. termination state properties) vs. stream specific
 - For each media stream
 - Local properties
 - Properties of received streams
 - Properties of transmitted streams
 - Mandatory vs. optional
 - Options are grouped in packages

Megaco/H.248: Concepts - Termination

Examples of properties/descriptors

- Streams
 - Single bidirectional stream
 - Local control: Send only – send/receive ...
 - Local: media received
 - Remote: media sent
- Events
 - To be detected by the MG and reported to the controller
 - On hook / Off hook transition
- Signals
 - To be applied to a termination by the MG
 - Tones
 - Announcements
- Digit map
 - Dialling plan residing in the MG
 - Detect and report events received on a termination ..

Megaco/H.248: Concepts - Context

Context (mixing bridge)

- Who can hear/see/talk to whom
- Association between terminations
- May imply
 - Conversion (RTP stream to PSTN PCM and vice versa)
 - Mixing (audio or video)
 - Null context
 - Terminations that are not associated with no other termination (e.g. idle circuit switched lines)
 - Topology
 - Precedence

Megaco/H.248: Protocol - Commands

Add termination to a context

Modify the properties of a termination

Subtract a termination from a context

Move a termination from a context A to context B

Audit (values or capabilities)

Notify

ServiceChange (specific type of notify – terminations about to be taken out of service)

Megaco/H.248: Protocol - Transactions

Possibility to send several commands in one go

- Transaction Request
- Transaction Reply
- Transaction pending

Megaco/H.248: Protocol - Transportation

Several alternatives

An example

- UDP/IP
 - Unreliable, timeouts / resends
 - At most once functionality required (Receivers should keep track of received commands)

Megaco/H.248: PSTN / NGN Interconnection ...

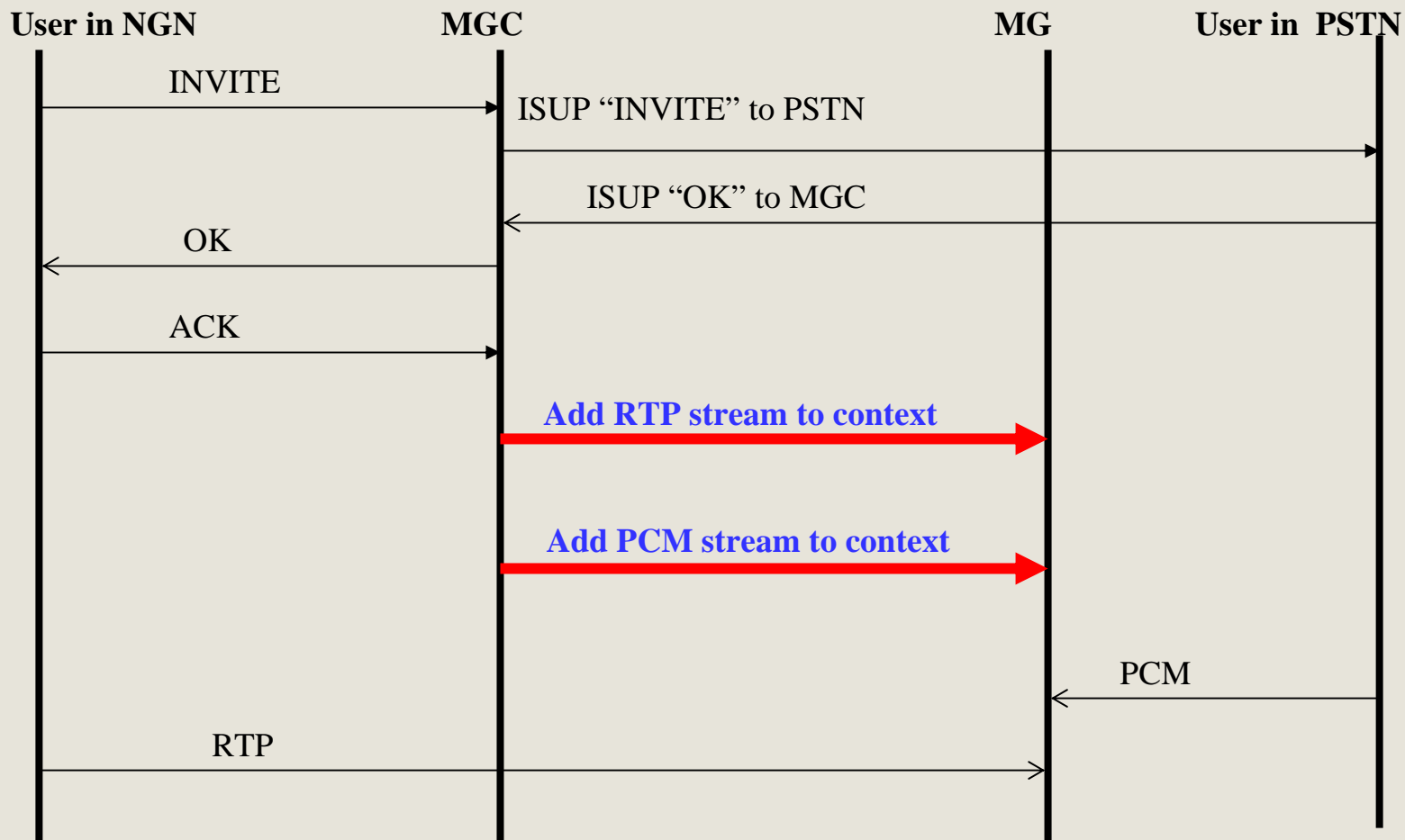

Megaco/H.248: Conferencing ...

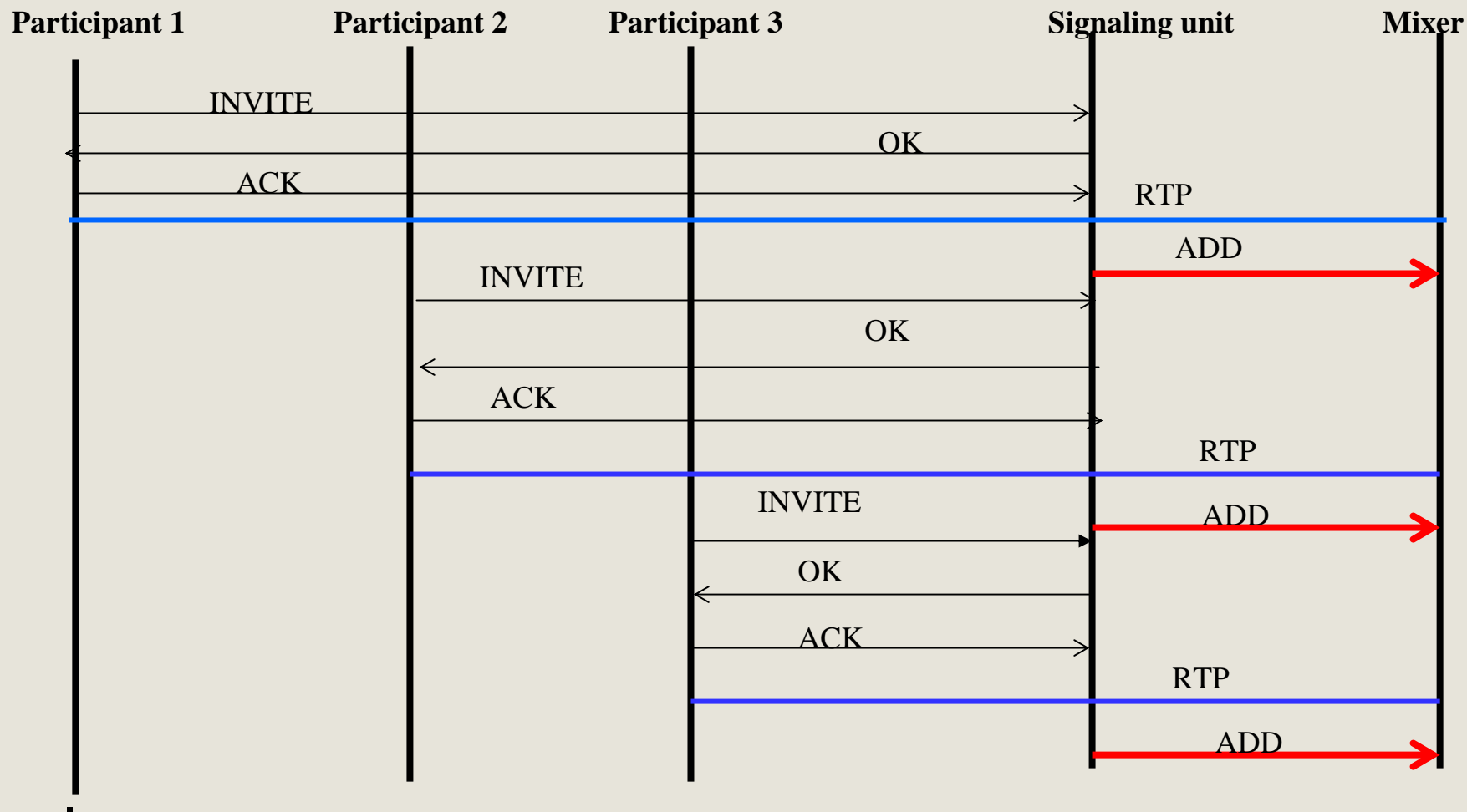

Megaco/H.248: Megaco IP phones

Phone considered as a media gateway ...

- Terminations
 - User interface
 - Audio transducers
 - Hands free
 - Headset
 - Microphone
- Interactions
 - Add
 - Move
 - Subtract
 - Modify

Soft-switches

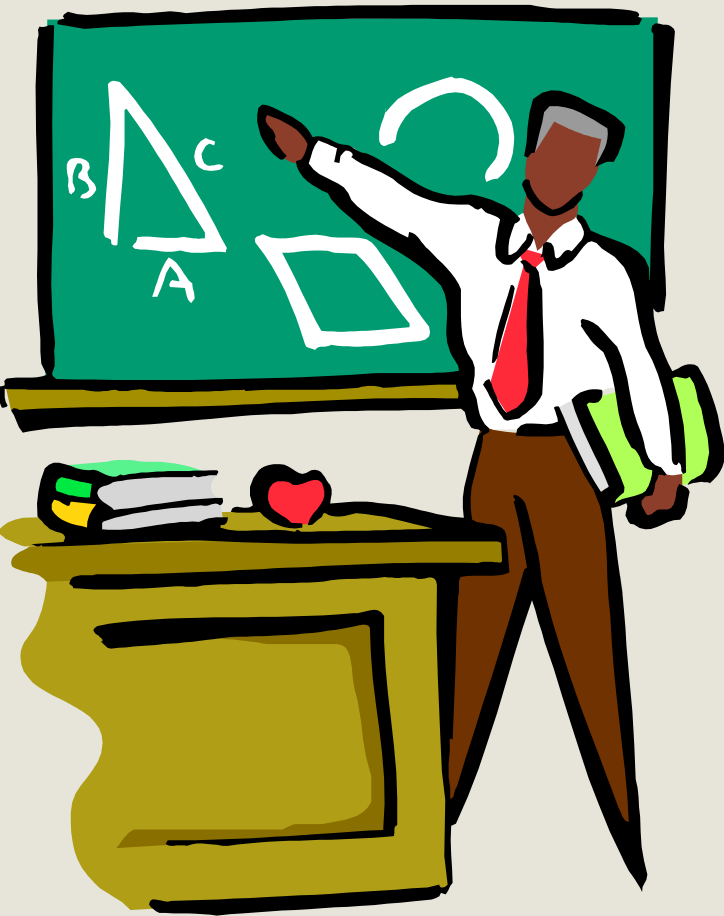

1. Introduction

2. Overview

3. A simplified call case

Soft-switch: Introduction

A “side effect” of media gateway decomposition

- Aggressively promoted by the soft-switch consortium, now known as the International Packet Communication Consortium (IPCC)
 - Adoption of existing standards (e.g. SIP, H.323, MGCP, Megaco)
- Gateway controller (plus some additional features) acts as a switch
 - Switching in software instead of hardware
- Can act as local exchange (class 5) or toll centre (class 4)
 - Lower entry costs for new incumbents
 - New local telephony networks and “by pass” for long distance call providers
- Soft-switches vs. classical switches debate
 - Scalability
 - Reliability
 - QoS

Soft-switches : Overview

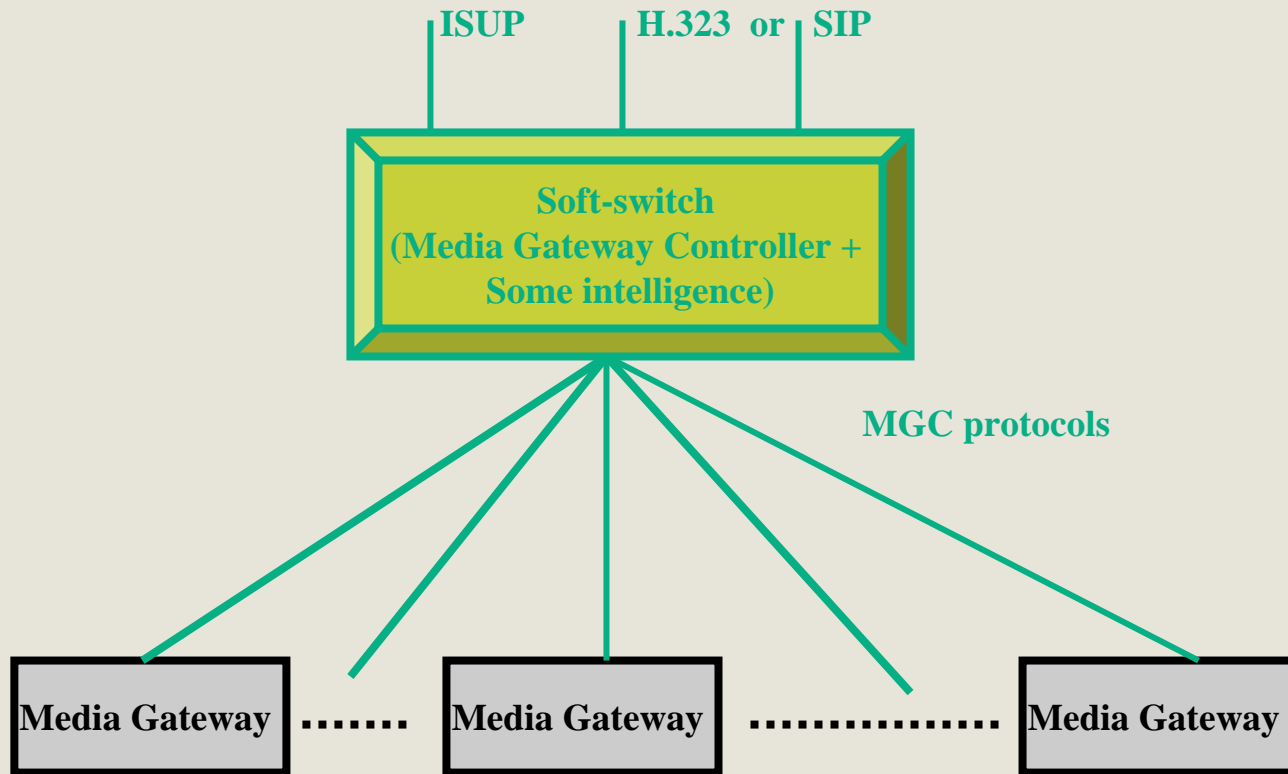

Soft-switches : Overview

An example of soft-switch as class 5 replacement ...

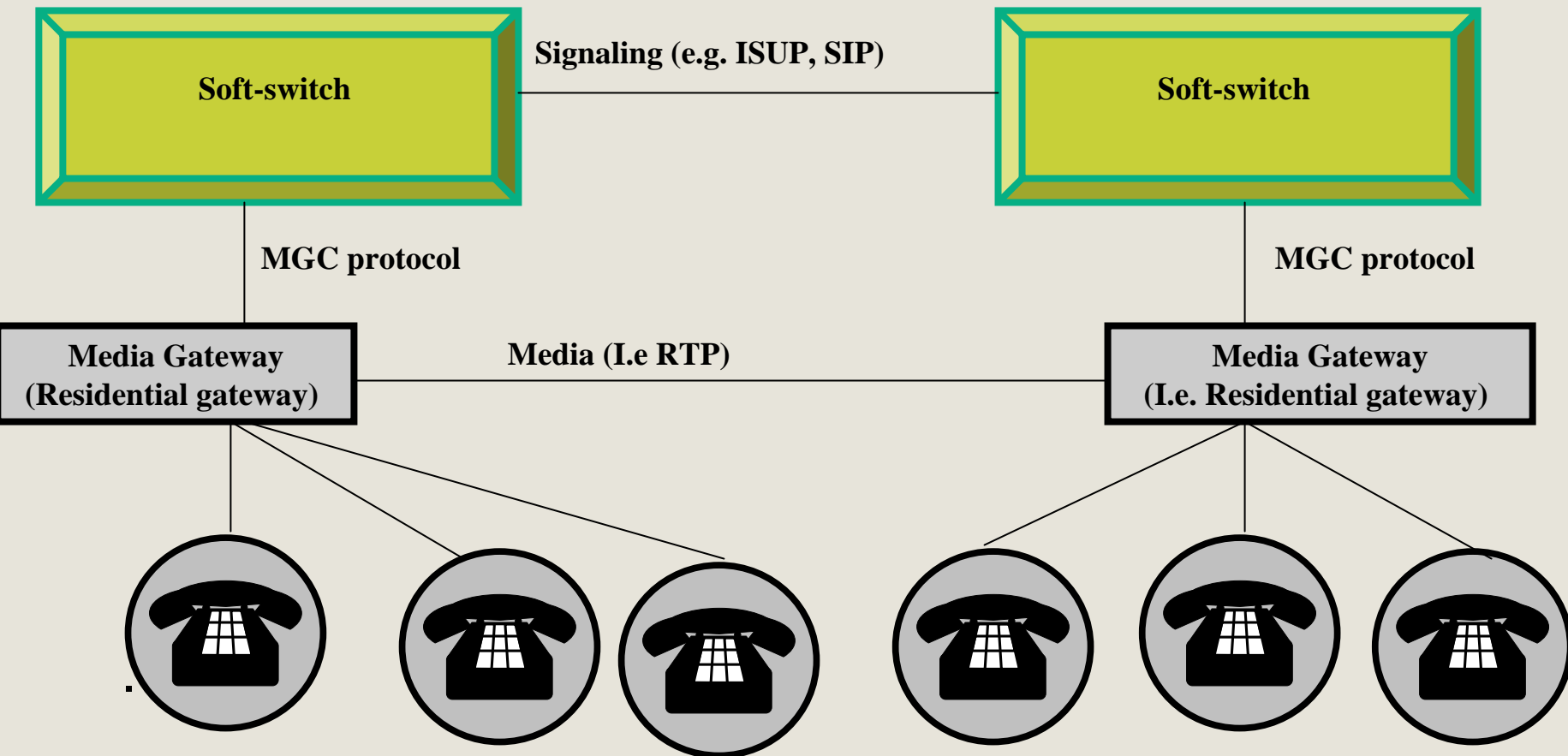

Soft-switches : Overview

An example of soft-switch as class 4 replacement ...

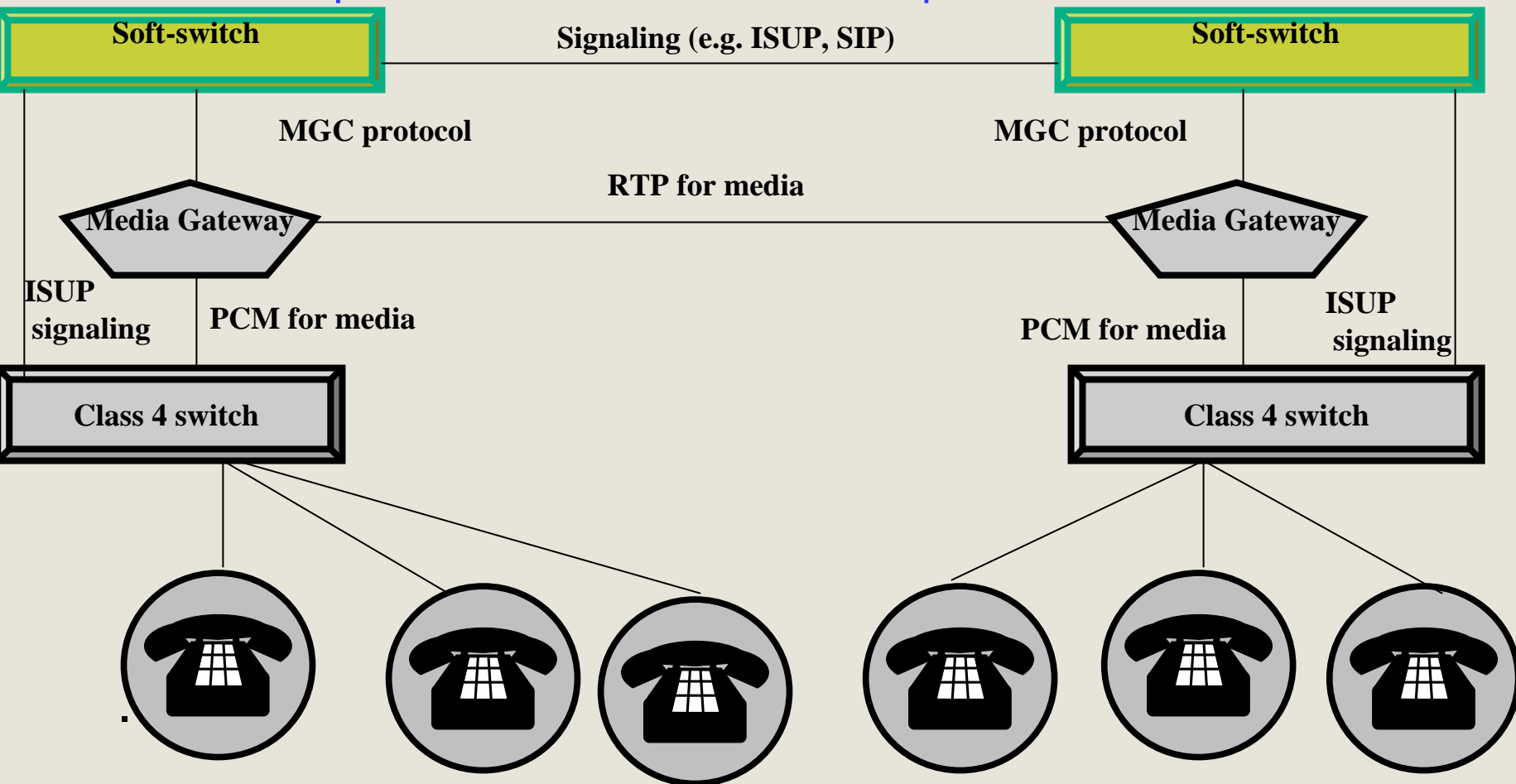

Soft-switch: A simplified call case (Calling card)

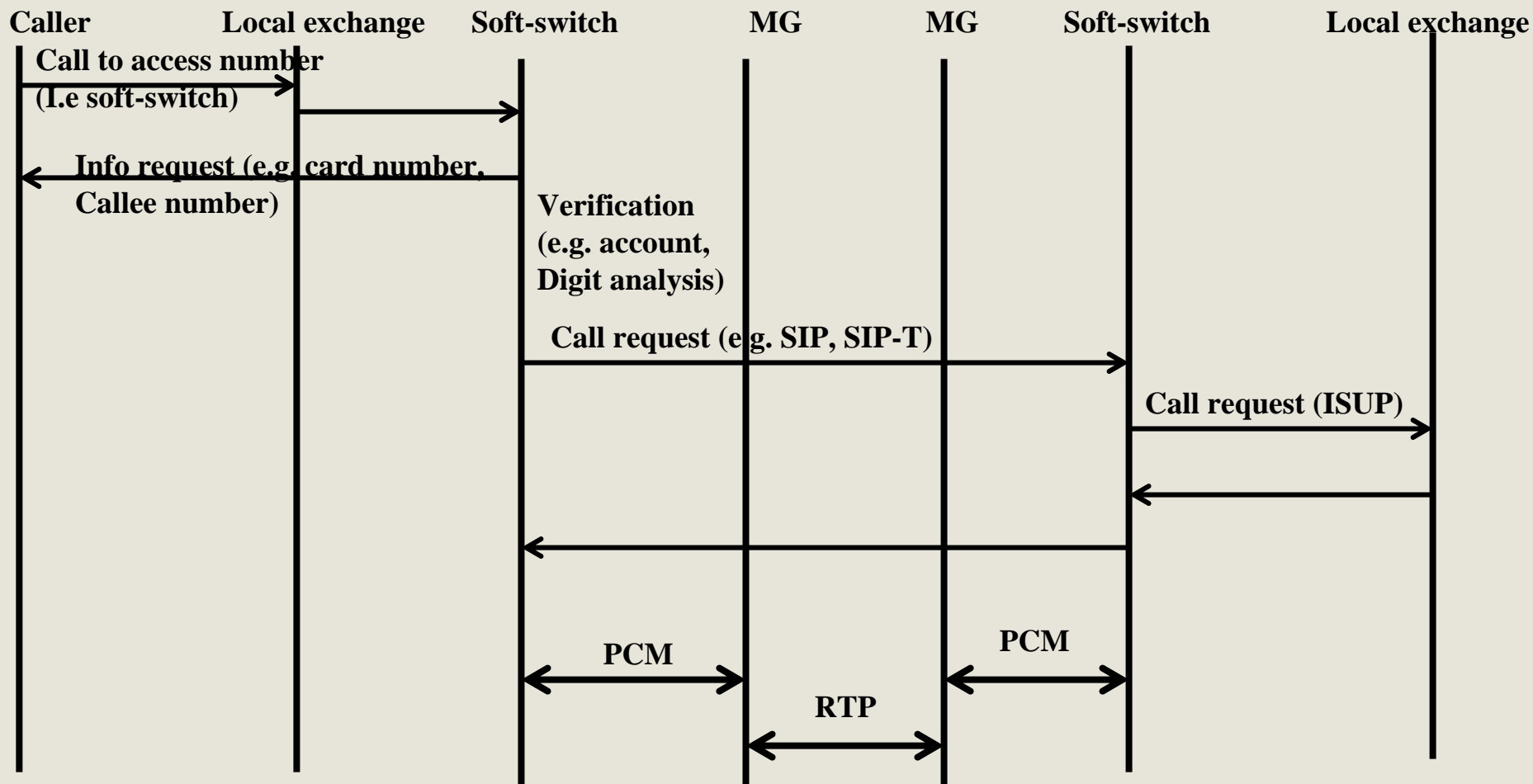

References ...

1. Moderassi and S. Mohan, special issue, *Advanced Signaling and Control in Next Generation Networks*, IEEE Communications Magazine, October 2000 – Include papers on:
 - H.323
 - SIP
2. Additional references on Megaco/H.248
 - RFC 3525 (The protocol)
 - RFC 3054 (IP Phone)