

Circuit Switched Telephony and Related Architectures

INSE 7110 – Winter 2008

Value Added Services Engineering in Next Generation Networks

Week #2

Outline

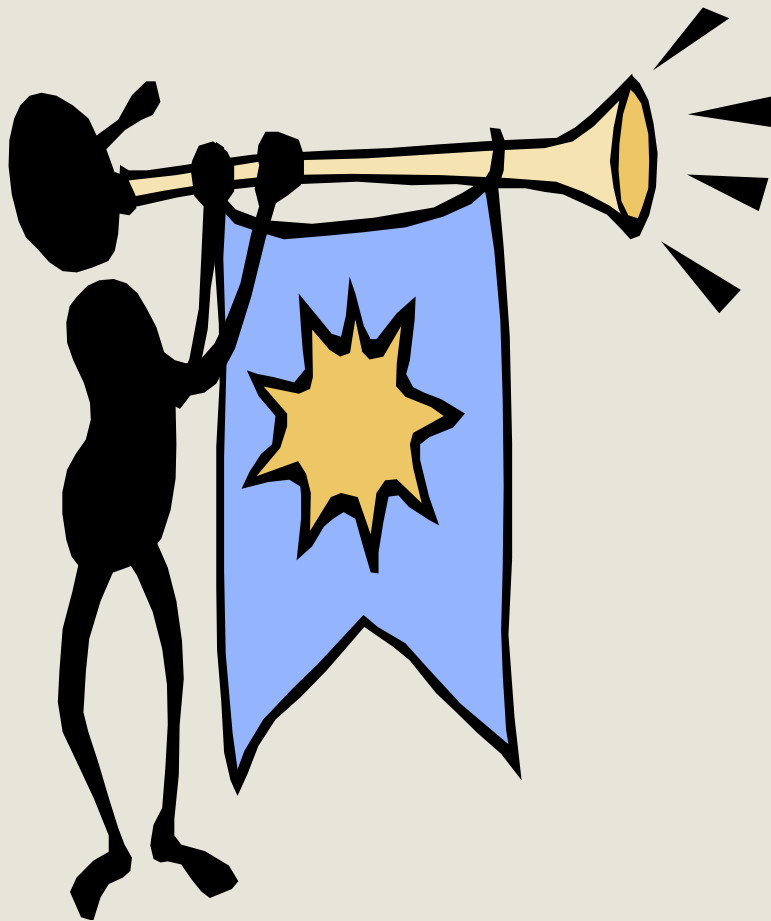

1. Essentials of circuit switched telephony
2. Introduction to value added services
3. IN
4. WAP
5. TINA-C
6. References

Essentials of circuit switched telephony

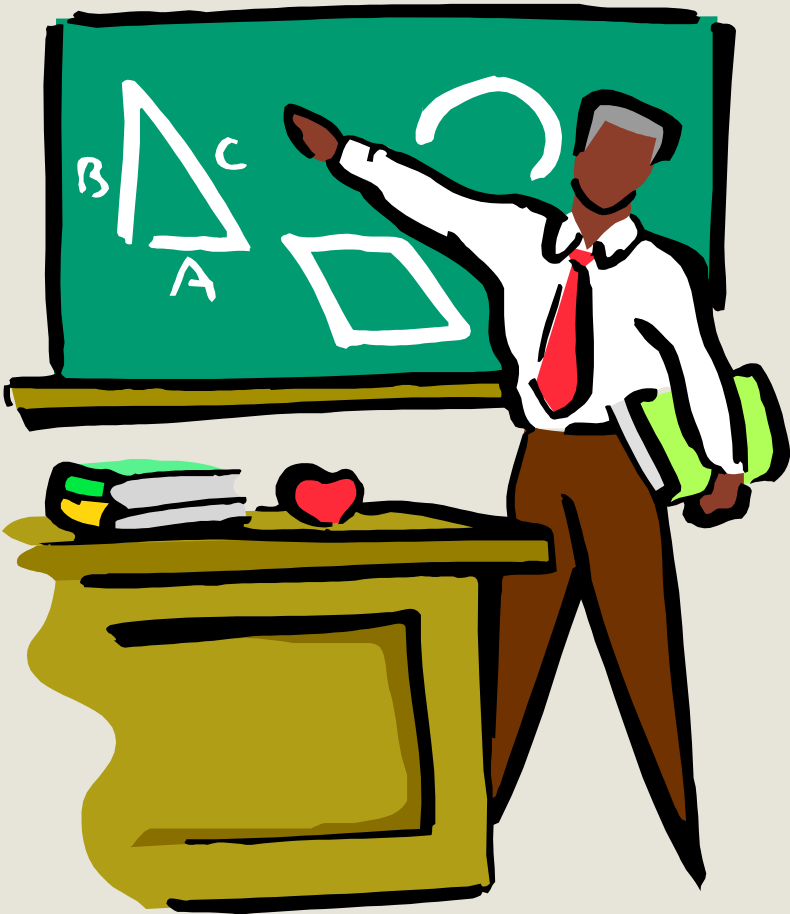

- Circuit switching vs. packet switching
- Local loops, telephone exchanges and trunks
- Signaling
- Beyond fixed telephony

Circuit switching vs. packet switching

Principal Criteria	Circuit switched	Packet switched
Dedicated Physical path	Yes/No	Yes/No
Derived criteria	Circuit switched	Packet switched
Call set up required	Yes/No	Yes/No
Possibility of congestion during communication	Yes/No	Yes/No
Fixed bandwidth available	Yes/No	Yes/No
Non optimal usage of bandwidth	Yes/No	Yes/No

A simplified telephony network ...

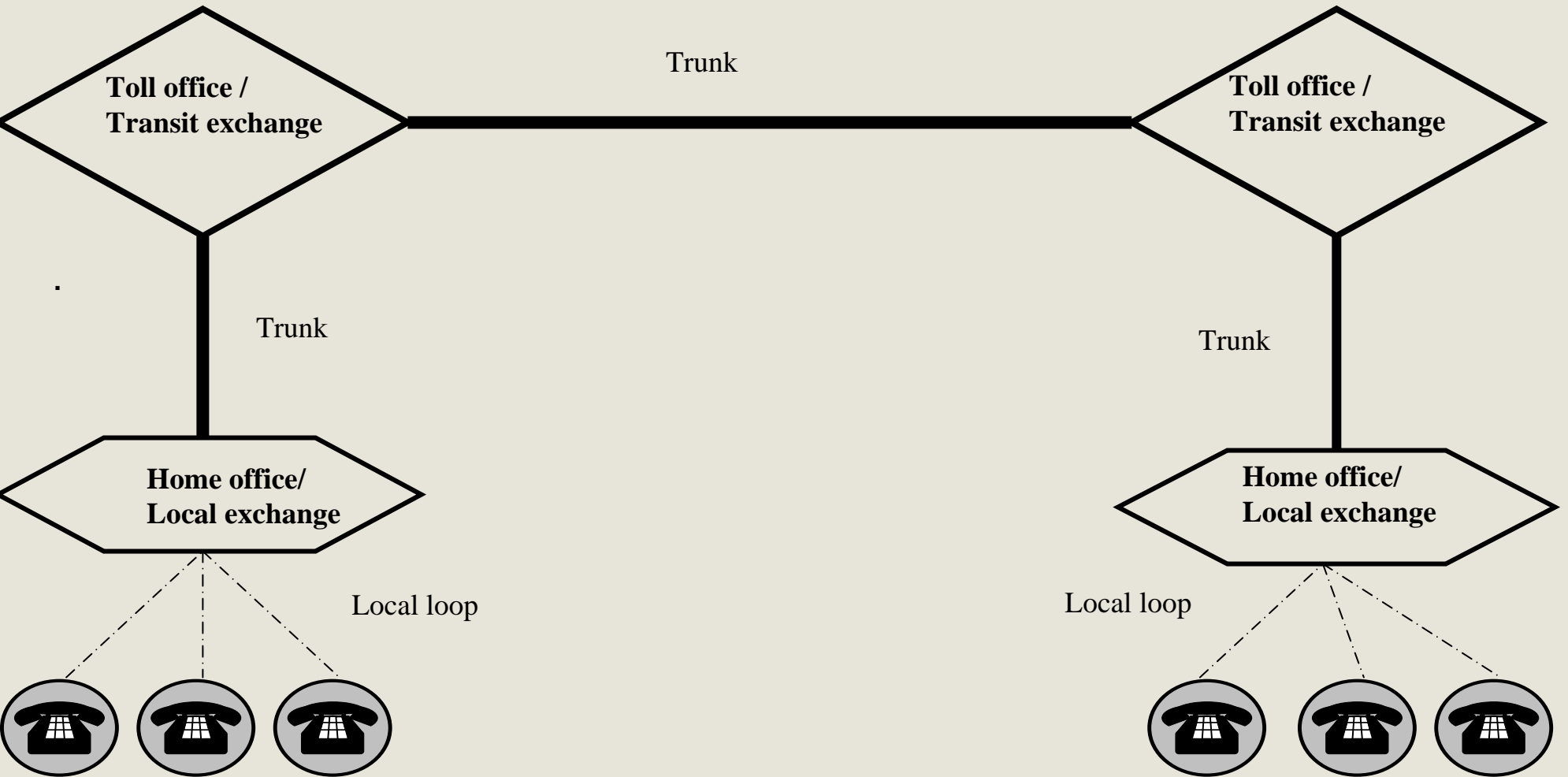

Signaling ...

Establishment, modification and tear down of calls

- **User Network Signalling**

- Between user and home office
- On/off hook, dial tone ...
- Carried over local loops

- **Network – Network signalling**

- Between telephone exchanges
- Initially in-band (Same trunks as voice)
- Out-band in modern circuit switched telephony
 - Signalling data carried over a separate and overlay packet switched network (Signalling System no7 – SS7)

Signaling ...

Criteria	In-band signaling	Out-band Signaling
Potential capacity	More / less	More / less
Potential speed	More/less	More/less
Room for fraud	More/less	More/less
Flexibility (e.g. mid-call signaling)	More / less	More / less

A Simplified SS7 network architecture ...

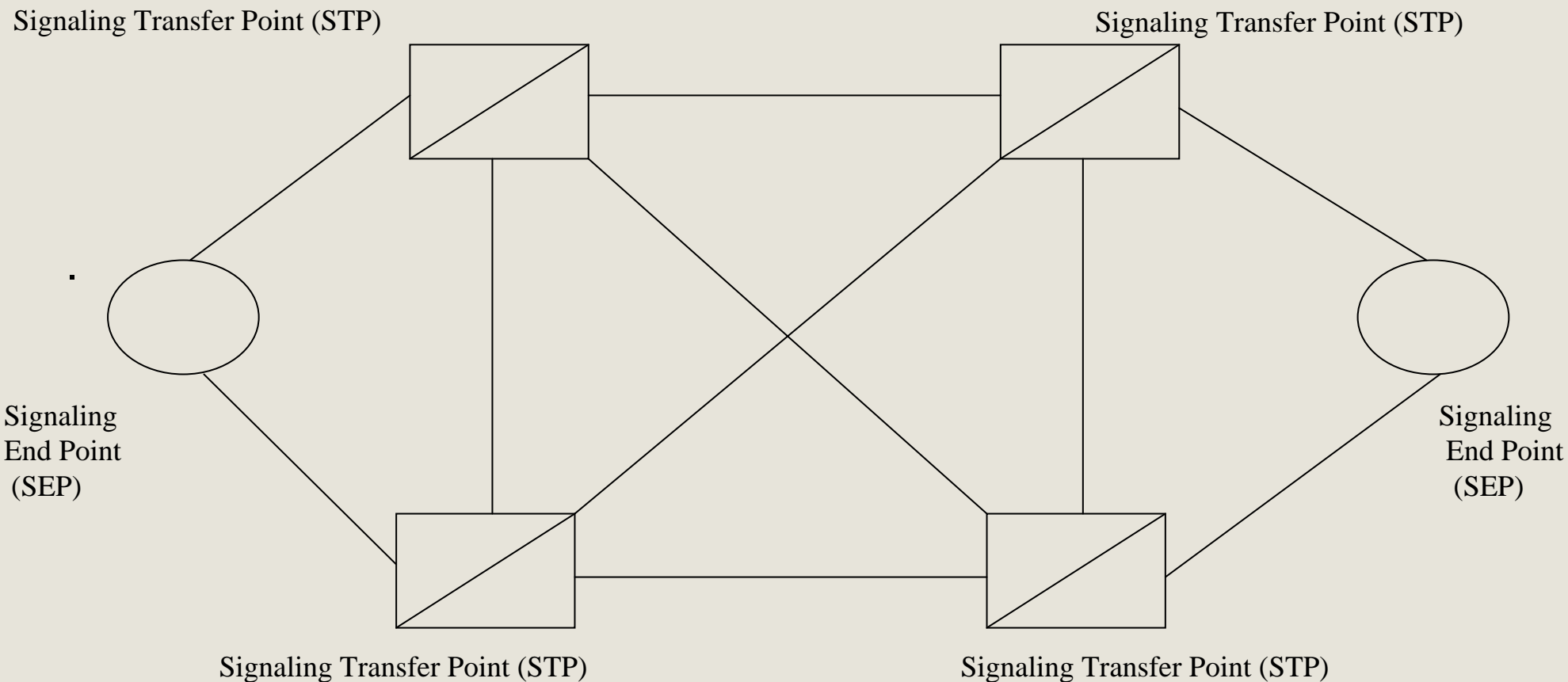

SS7 Protocol stack ...

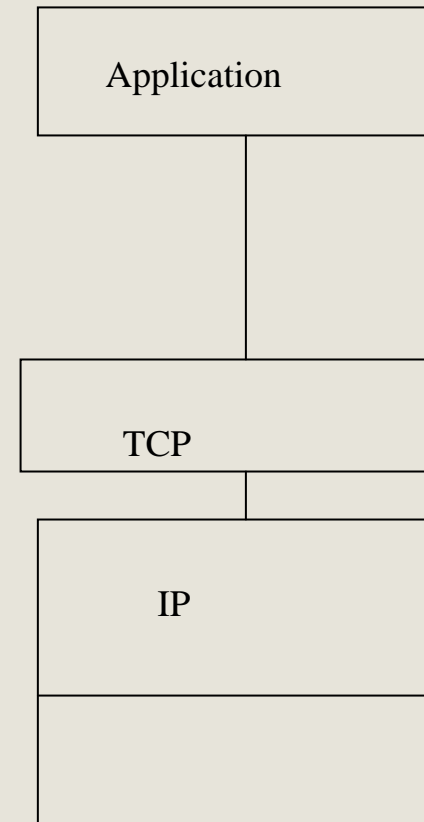
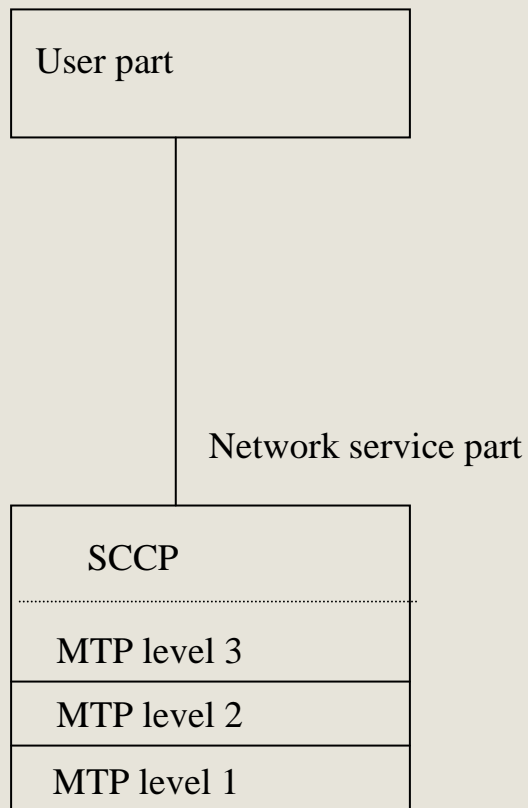
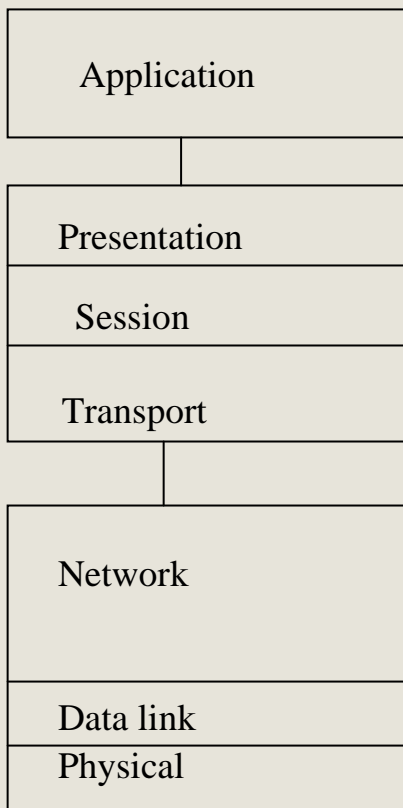

Integrated Service Digital Network (ISDN) - User Part

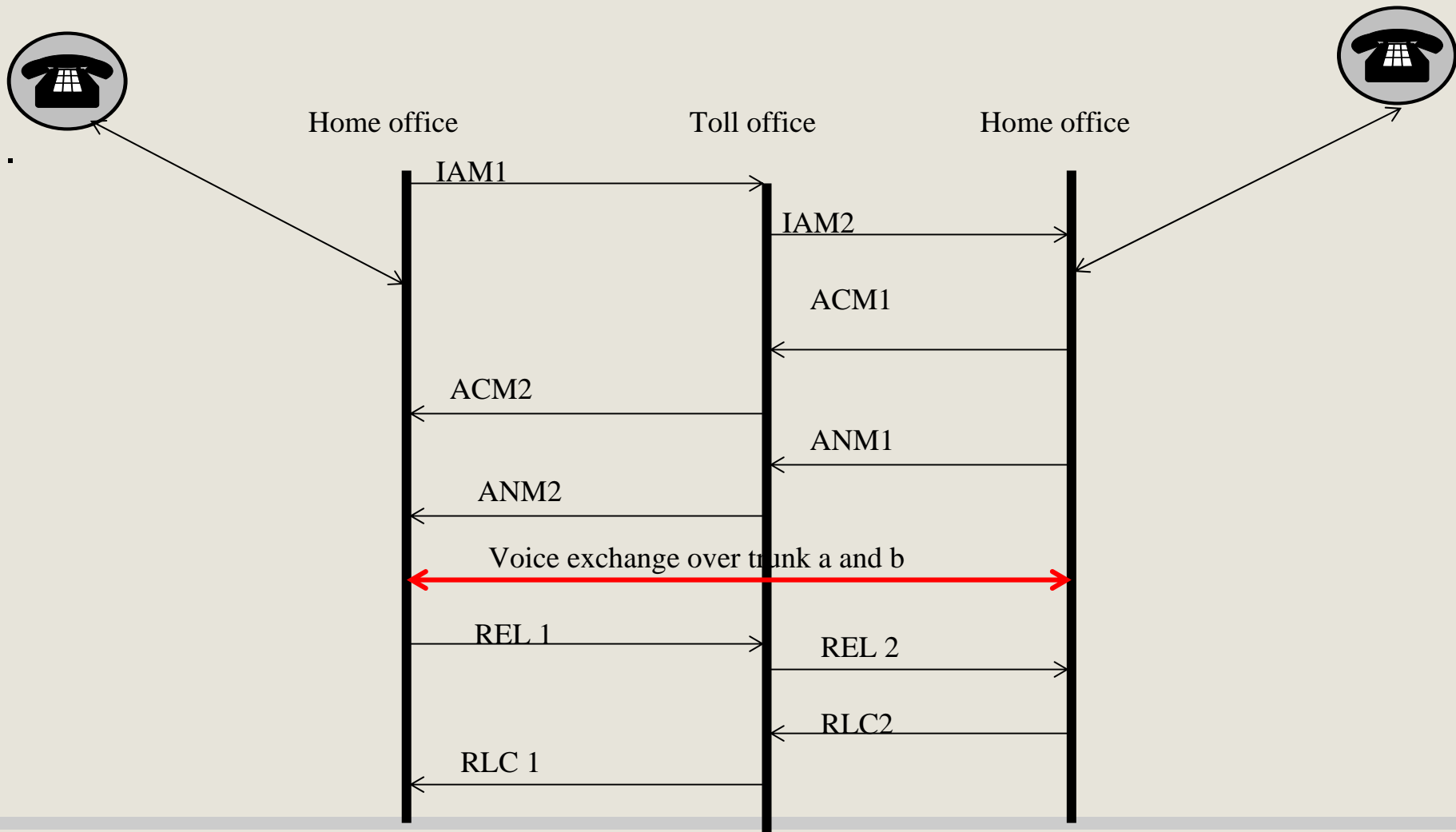

Beyond fixed telephony ...

Cellular telephony

- Mobile Switching Centre
 - Switches used in cellular telephony – Additional features for mobility management
- Home location register (HLR) /Visitor location register (VLR)
 - Keep information on user location
- Base stations
 - Access point to cellular networks
 - Communicate with end user terminals
 - Control cells
- Signalling in cellular networks
 - SS7 based

Mary a Montreal subscriber receives a call while in Vancouver

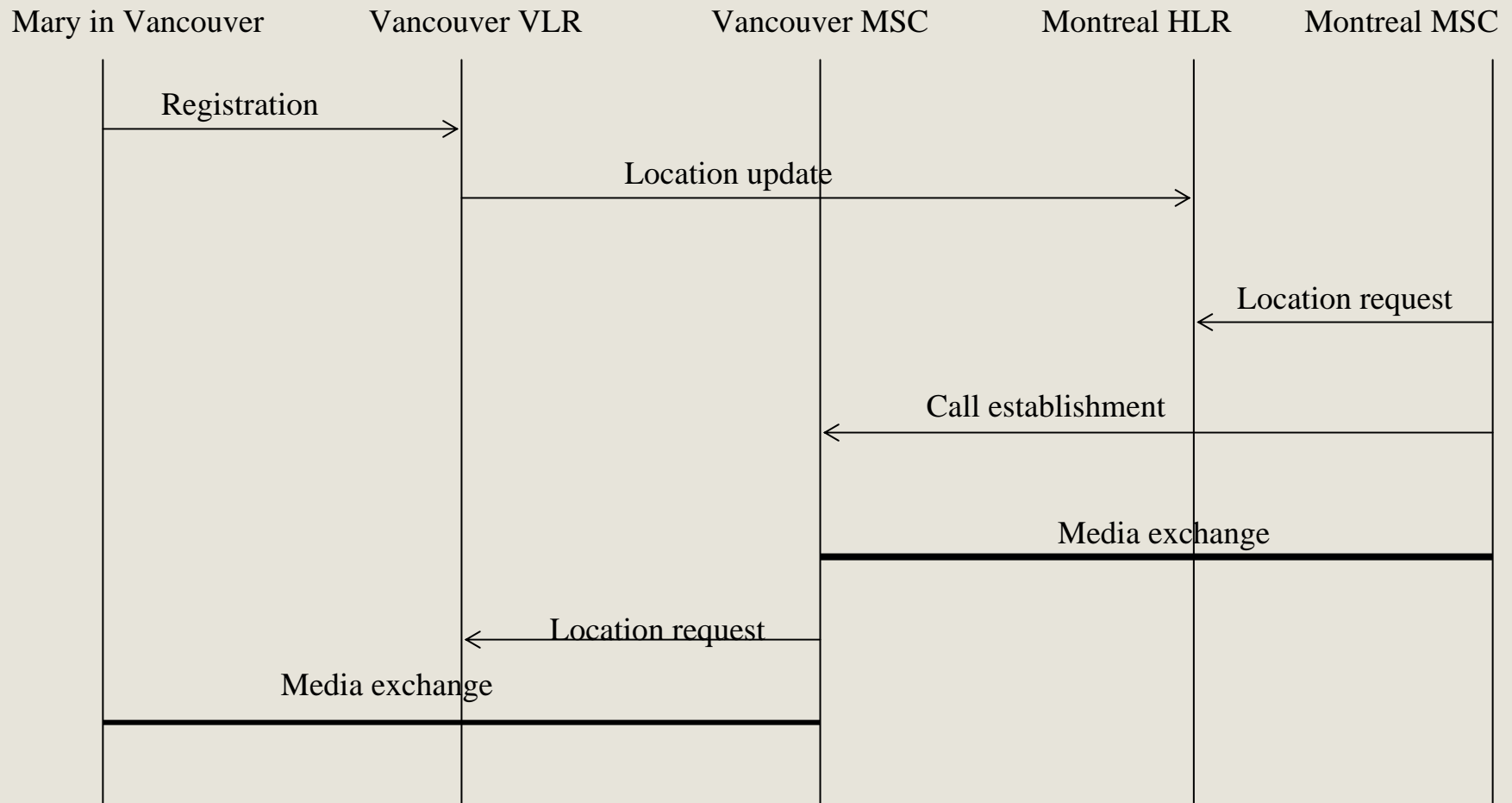

Beyond fixed telephony ...

First generation cellular networks (70s – 80s)

- Analog systems, circuit switching based
 - Total Access Communications Systems (TACS) – UK
 - Advanced Mobile Phone Systems (AMPS) – USA/Canada
 - Nordic Mobile Telephone System (NMT) – Scandinavia

Second Generation (90s – early 00s)

- Digital systems, circuit switching based
 - GSM – Europe mainly – However, gaining ground in North America
 - D-AMPS (Digital version of AMPS)
 - PDC (Japan)

Third Generation (early 00s –)

- Still digital, but more capacity
- Packet switching based
- Two main standards
 - UMTS
 - CDMA 2000

Introduction to value added services ...

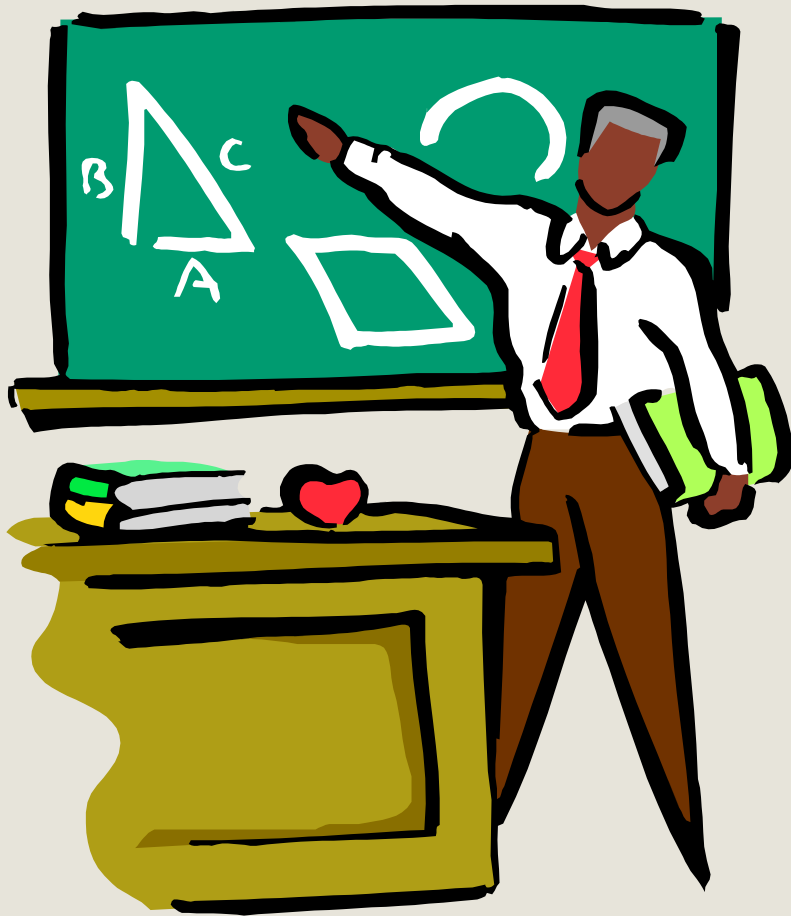

1. Services
2. Life Cycle
2. Service Engineering

Services ...

Basic service offered by circuit switched telephony: Two party voice call

Value added services

Anything that goes beyond two party voice call

- Telephony services
 - interact with call control
 - » Call diversion
 - » Call screening
- Non Telephony services
 - Web access from a cell phone
 - » Surfing
 - » Email

Service life cycle ...

Four phases

- **Creation (also known as construction)**
 - Specification, design/coding, and testing
- **Deployment**
 - Service logic (or executable) resides on specific node(s) and needs to be deployed there
- **Usage**
 - Subscription/billing, triggering, features interactions
- **Withdrawal**
 - Removal from network

Service Engineering ...

Key issue: How to engineer “cool” services

- In more academic terms
 - Issues related to the support of all the phases of the life cycle.
 - Creation
 - Deployment
 - Usage
 - Withdrawal
 - These issues are architectural issues
 - Concepts, principles, rules
 - Functional entities, interfaces and algorithms

Service Engineering ...

Why is it an important discipline?

- **Business standpoint**
 - High quality two party voice call is now a commodity
 - Value added services are needed to attract subscribers and generate revenues.
- **Engineering standpoint**
 - It is less than trivial
 - Example: Service creation
 - Secure and selective access to network resources is required
 - Related issues: Level of abstraction, security framework, service creation tools ...etc.

Service Engineering ...

Architectures for circuit switched telephony

- Intelligent Network (IN)
- Wireless Access Protocol (WAP)
- Telecommunication Information Network Architecture (TINA)

▪

Service architectures for today's networks

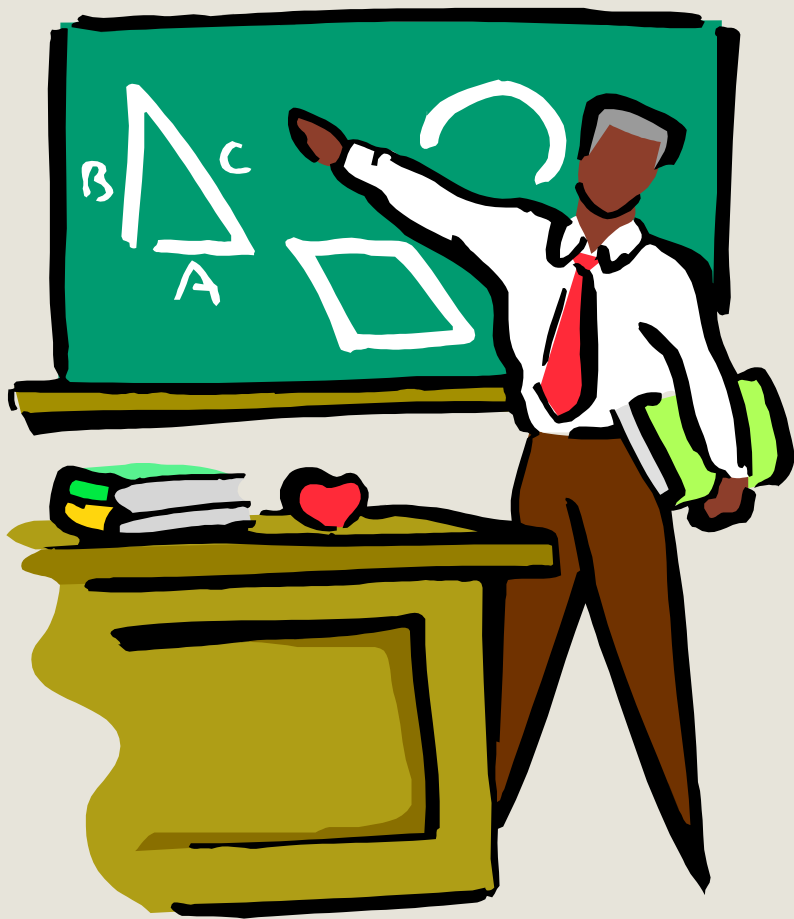

1. IN
2. WAP
3. TINA-C

Introduction to IN ...

The pre-IN era

- Service logic embedded in switching software

IN

- Has emerged in the ITU-T based on work done at Telcordia (alias Bellcore), in the late 80s
- Basis for:
 - AIN (North America - fixed network)
 - Wireless Intelligent Networks (WIN) - (D-AMPS - wireless network)
 - Customized Application Mobile Enhanced Logic (GSM - wireless network)

IN: Fundamental Principles

1. Separation of switching software and service logic

Main implication: Need for an interaction model between switching and service

- Functional entities / nodes
- Protocols

2. Standardization of capabilities for building services

Main implication: Need for “components” that can be used in various ways for building services

IN: Fundamental Concepts

Call model

Phases for setting up and tearing down calls

- IN call model or basic call process: call model with the possibility to invoke service
 - » Point of invocation
 - » Point of return

Service independent building blocks (SIB)

Components used to build services

- Have a logical start and one or more logical ends
- Are chained to build services

Capabilities set

- A set of potential services
- A given call model
- A set of SIBs
- A set of functional entities
- A protocol

IN: A four planes conceptual architecture

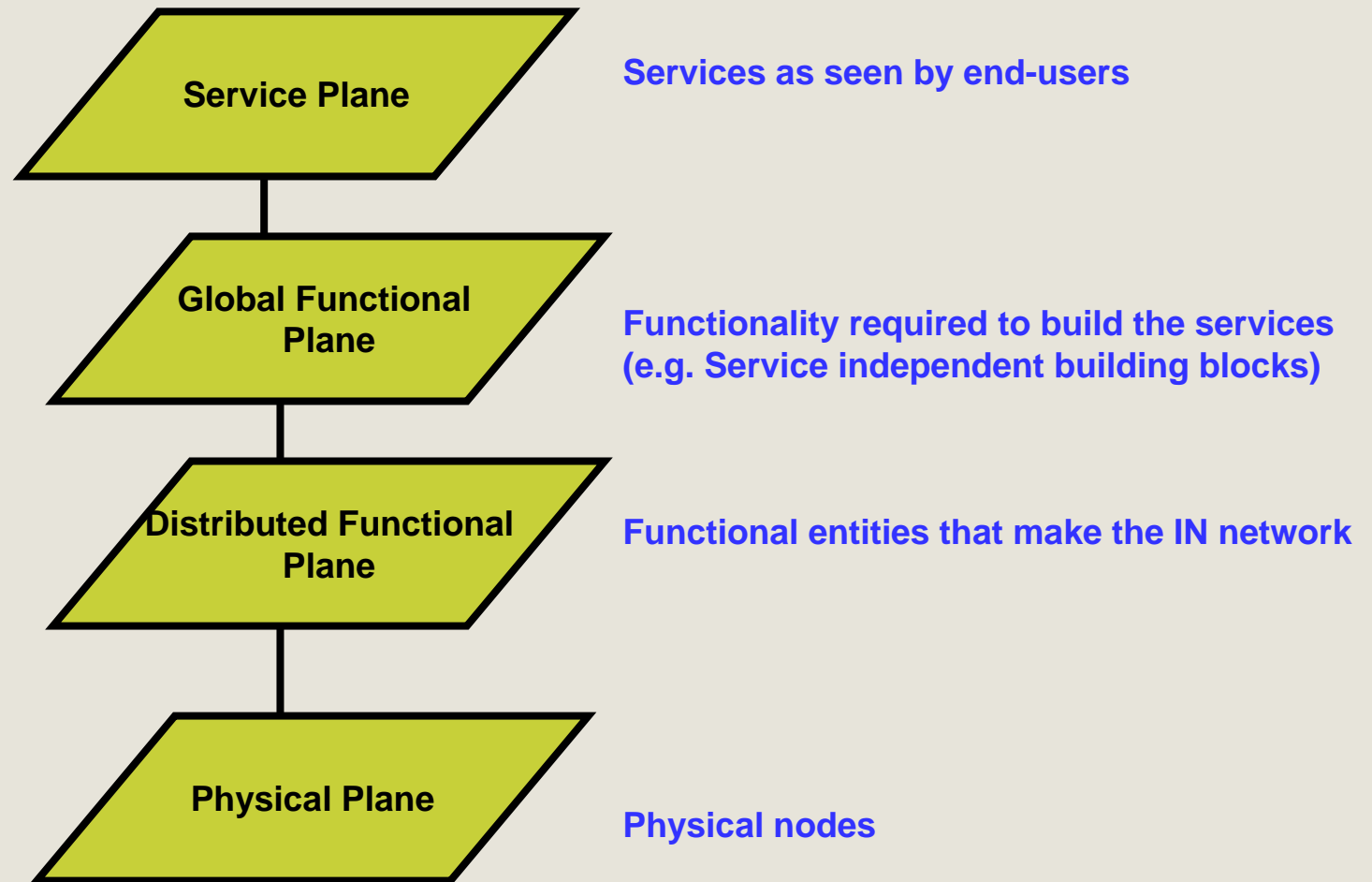

IN: Service Plane

Examples of services made of specific features

Free phone

- One number (800 in North America) feature
- Reverse charging feature

Calling card

- Charging feature
- Originating user prompting

IN: Global Functional Plane

...Simplified Free phone

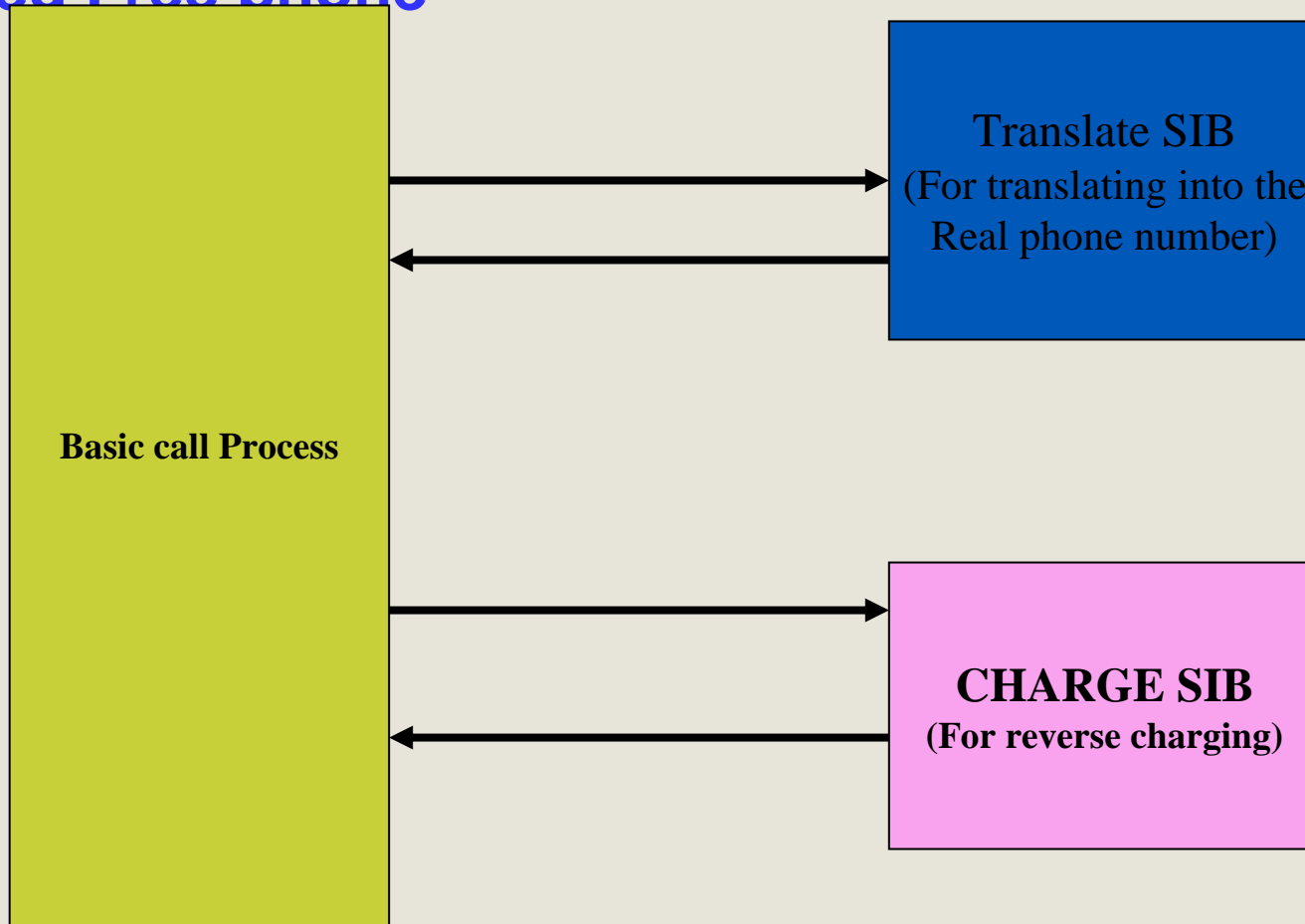

IN: Physical Plane ...

Functional entities can be grouped in nodes as manufacturers wish

The Intelligent Network Application Protocol (INAP) is used for communications between nodes.

- Request / Reply application level protocol
- Messages transported over SS7
- SS7
 - Overlay packet switched networks
 - Used for outband signalling
 - Made of
 - Message transport part
 - Application part

IN: Physical plane

An example of physical implementation ...

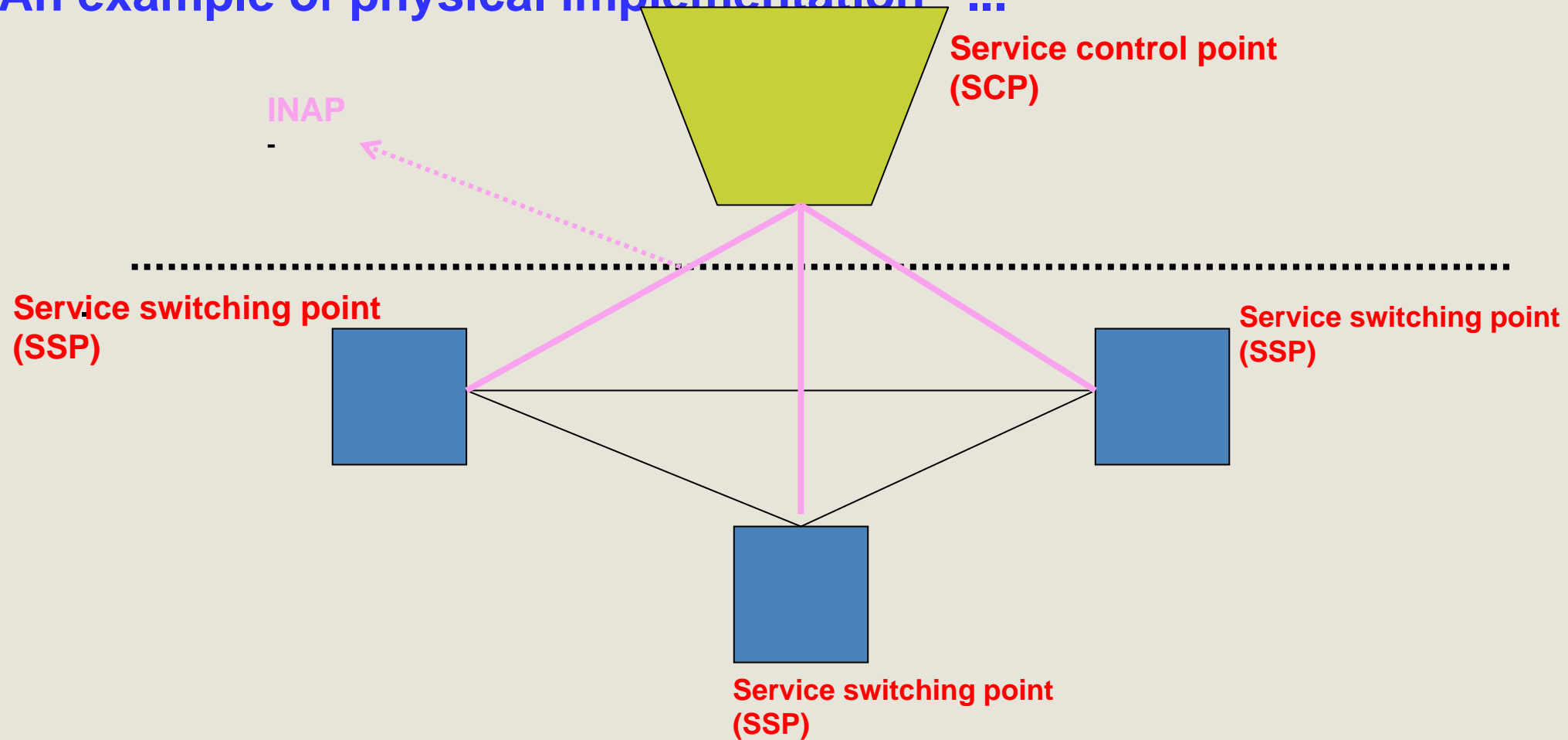

IN: Retrospective ...

A revolutionary concept

- Separation between service logic and switching software
- Standardisation of service capabilities instead of services

With mixed results

- Reasonable installed basis, but
- Lack of openness
 - Standardised building blocks (e.g. SIBs) did not open telecommunication networks to third parties
 - Components are not interfaces
 - Too many “proprietary” SIBs
- Service creation and deployment remain relatively slow
 - Immaturity of methodologies and tools
 - New service logic in SCPs often required “adjustments” to call model in SSP

WAP: Introduction

Product of an industry consortium, the WAP forum

- First release 1998 (WAP 1.0)
- Second release 2002 (WAP 2.0)
- Now transferred to the the Open Mobile Alliance (OMA)

Main objective: bring non telephony services to wireless users ...

- Web browsing
- Email

Raison d'être

- Limitations of cellular phones(Power, memory, battery)
- Limitations of today's wireless networks (Scarce bandwidth, unreliable links)

WAP: Fundamental principles

Optimal usage of “scarce” air interface resources

- Implications
 - Less bandwidth hungry protocols
 - binary encoding instead of text encoding

Optimal usage of “limited” terminal capabilities

- Implications
 - New description language(s)
 - New browser(s)

Independence of underlying bearer (e.g. GSM, TDMA, PDC)

Fundamental concepts

WAP Micro browser

- Browser adapted to limited terminal capabilities

WAP proxy/gateway

- Gateway between the Internet and operator's domain
 - Protocol gateway
 - Content adaptation
 - New description language(s)
 - New browser(s)

Application framework

- Application development / execution environment
 - APIs
 - Mark ups
 - Scripting

WAP: Basic Architecture

Protocol stacks (Legacy WAP 1.x stack + WAP 2.0 Internet protocol stack) ...

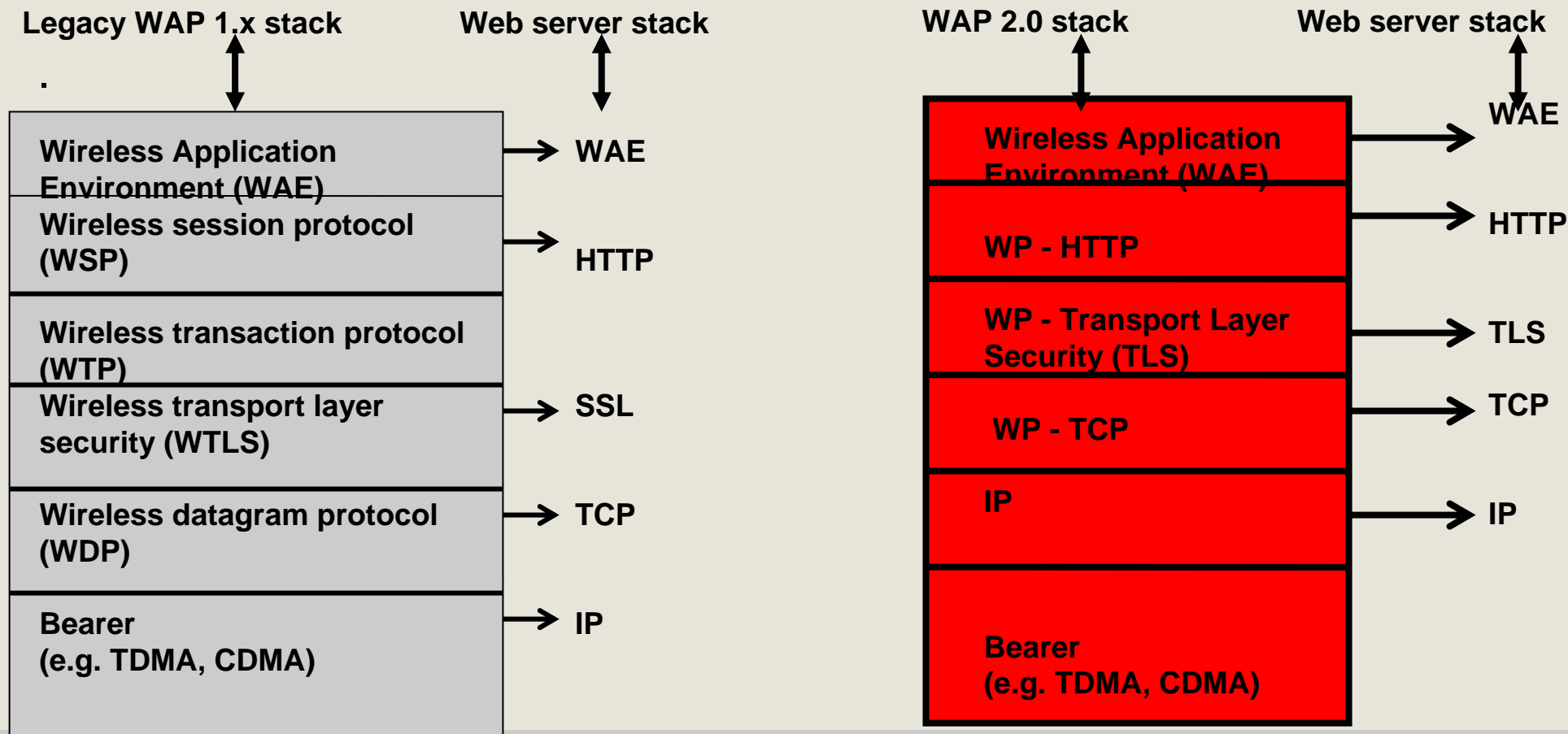

WAP: Basic Architecture

Network view

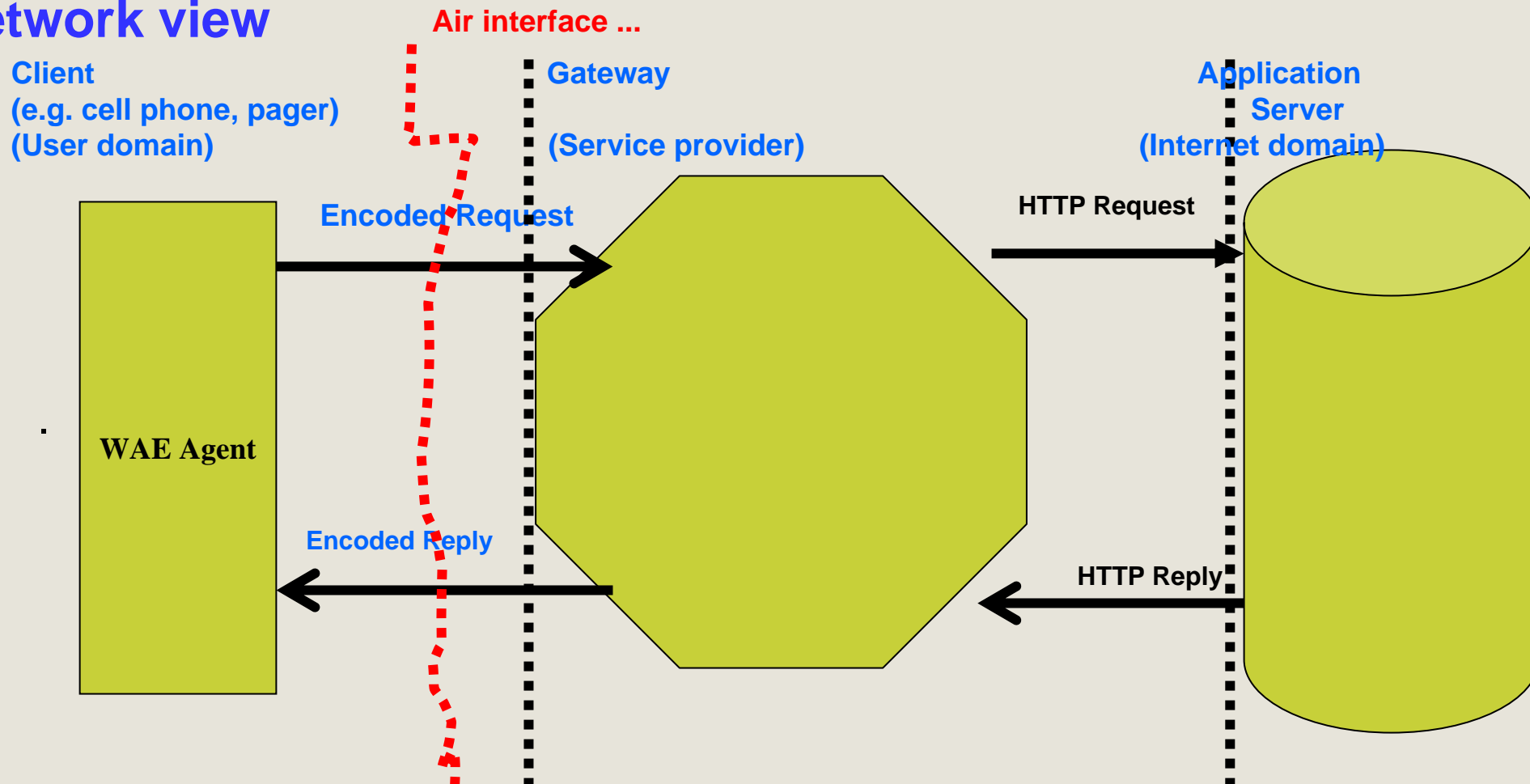

WAP: Beyond Internet wireless access ...

Push

- Information pushed to wireless device instead of the classical Internet pull model
 - Notifications (e.g. voice messages waiting to be retrieved)
 - News, traffic information

Wireless Telephony Applications

- Enhancements to call control services
 - Call initiation using an electronic agenda
 - On-line selection of how to handle a call (accept, reject, forward)

Multimedia messaging

- Interface between the client and the messaging server

WAP: Simplified Push

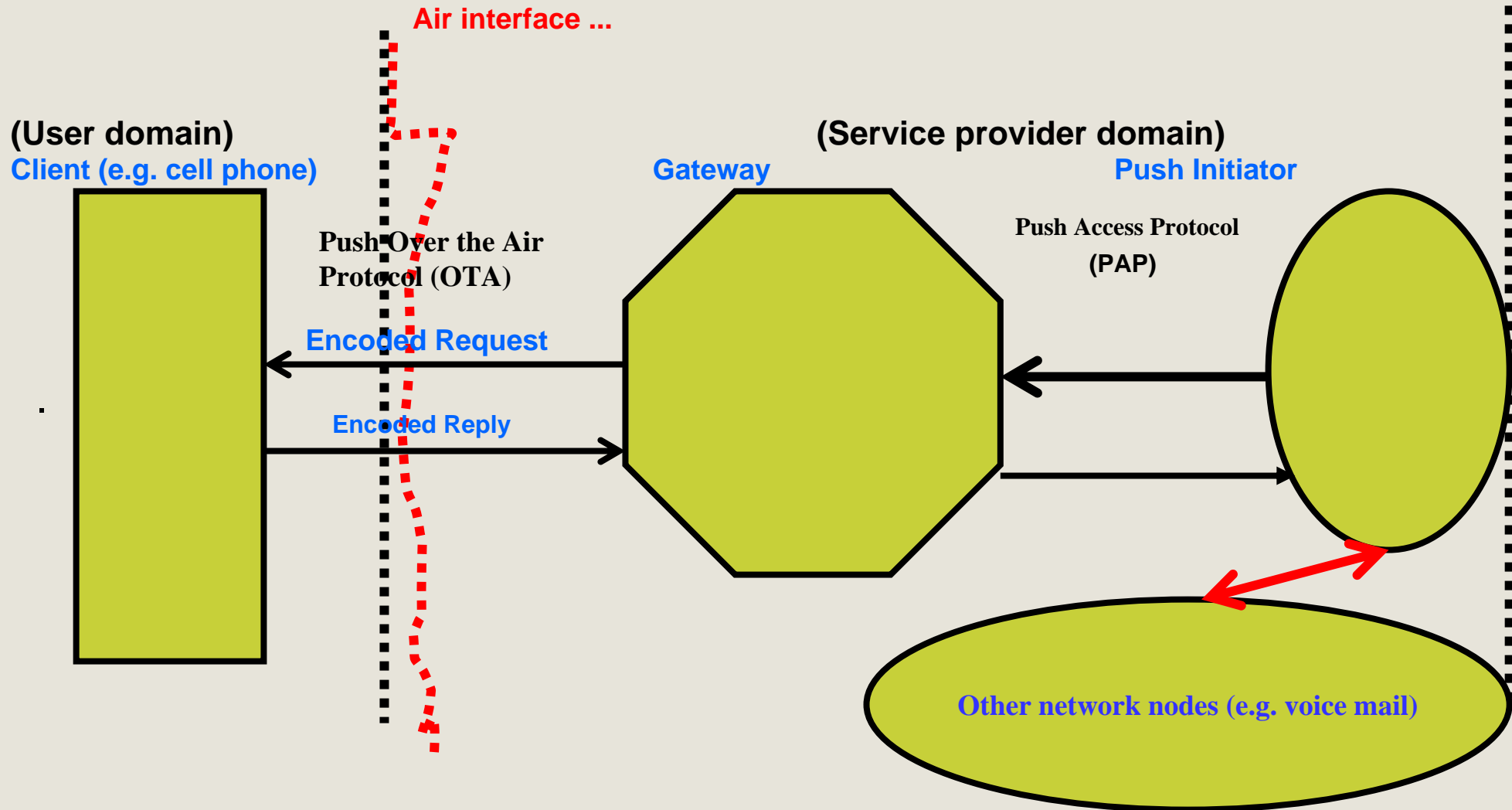

WAP: Simplified WTA

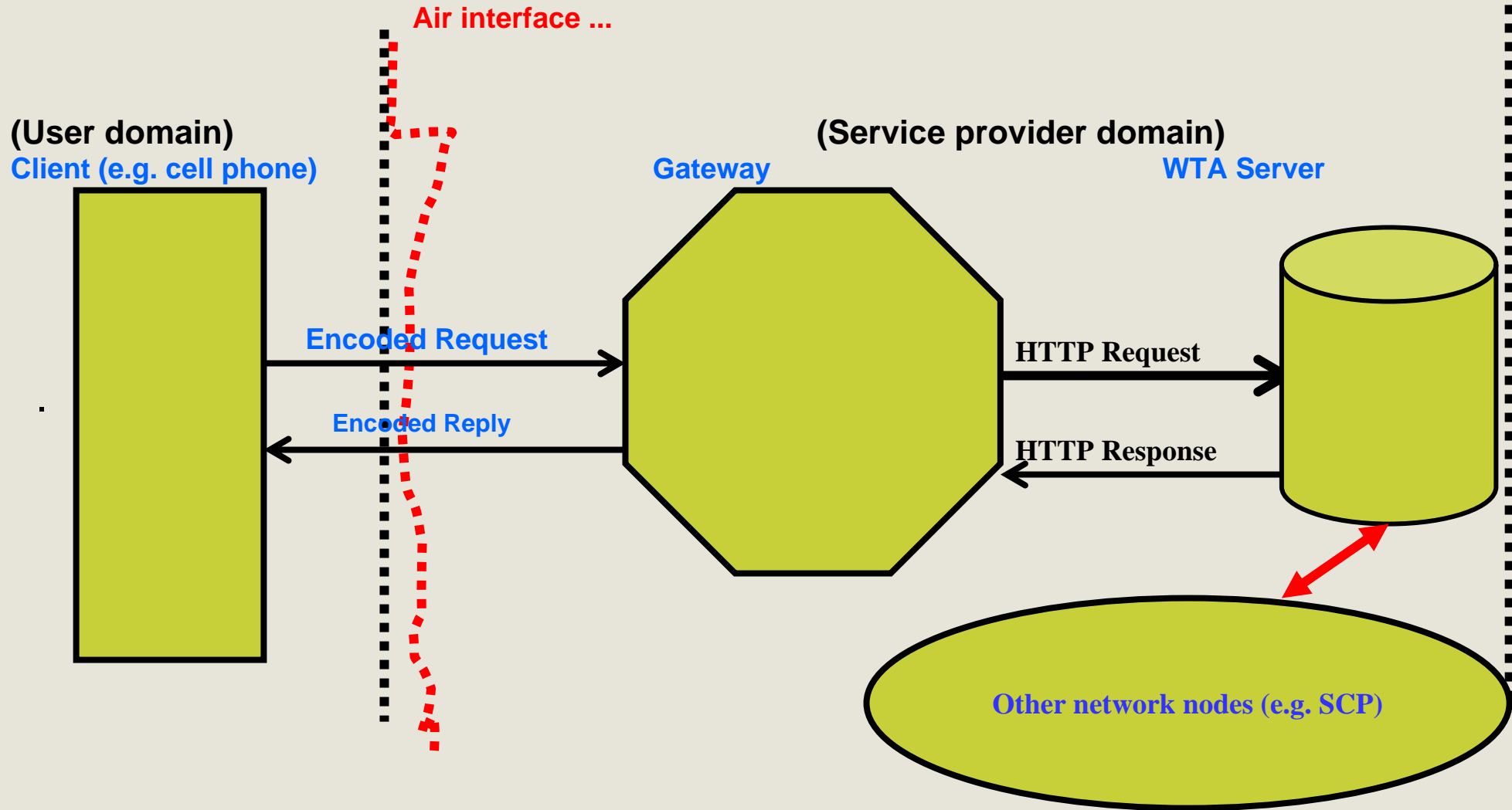

WAP: MMS

MM1 interface

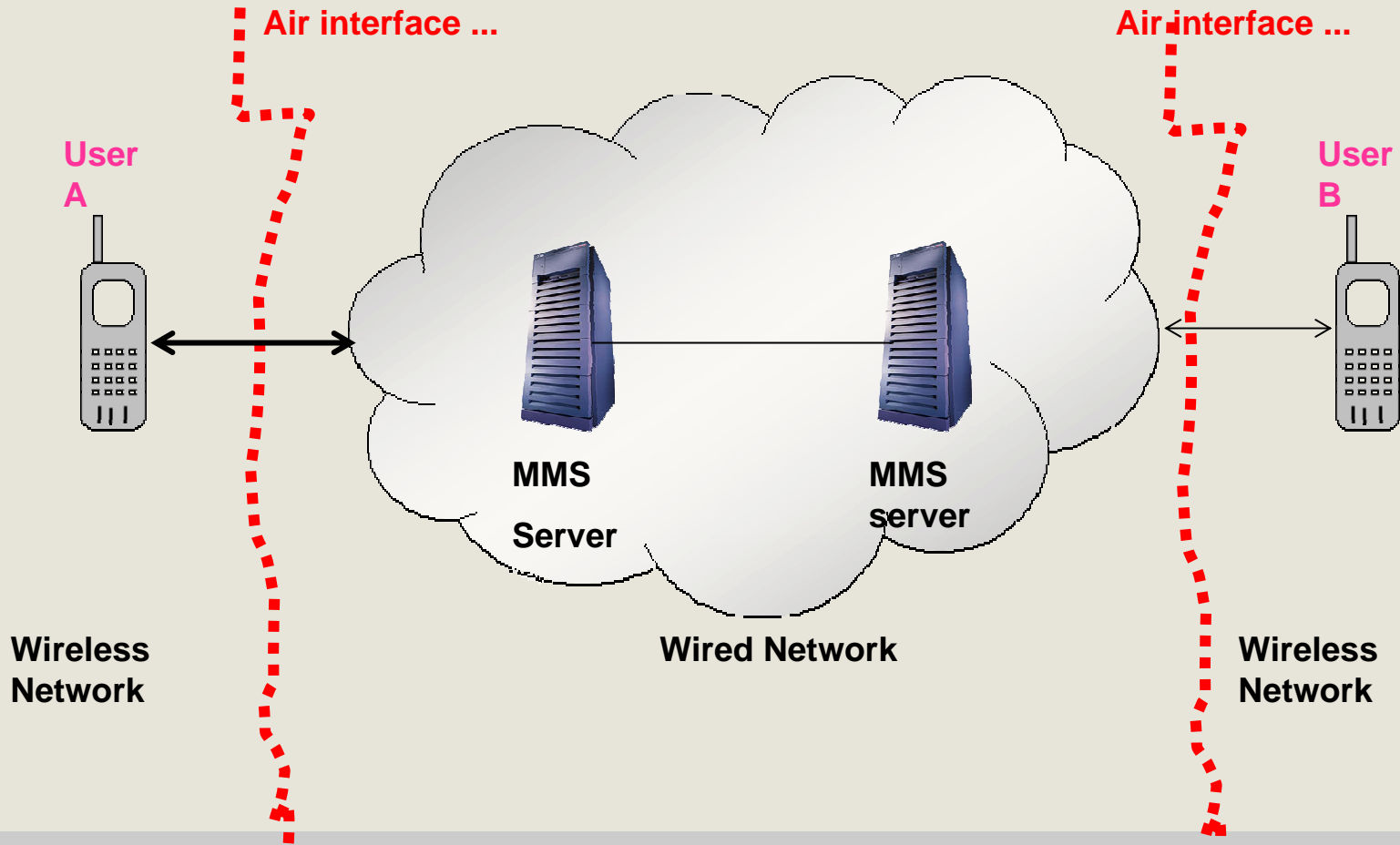

TINA: Introduction

Product of theTINA consortium (TINA-C)

- **First phase: 1993 - 1998**
 - Production of specifications by a core team based in same location (NJ, USA)
 - Validation (e.g. prototyping) by associated projects

- **Second phase: 1998 - 2000**
 - Special projects
 - Results promotion in various standards bodies

- **2000: Mission considered accomplished and dismantling of consortium**
 - Note: Many of the first phase participants did not join the second phase

TINA: Introduction

The context in the early 90s

- **Emergence of new technologies**
 - Object oriented technology
 - Distributed processing
 - Open Distributed Processing (ODP) specifications

- **Emergence of standards relying on different principles**
 - Intelligent Networks (IN)
 - Telecommunications Management Network (TMN)
 - Management of telecommunications network
 - » FCAPS

TINA: Fundamental principles

The separation principle

- Infrastructure
 - Service
 - Network
- Service
 - Subscription
 - Access
 - Usage
 - Service usage

Business model as starting point for specifications

- Roles
- Interfaces

TINA: Fundamental principles

Business roles / interfaces

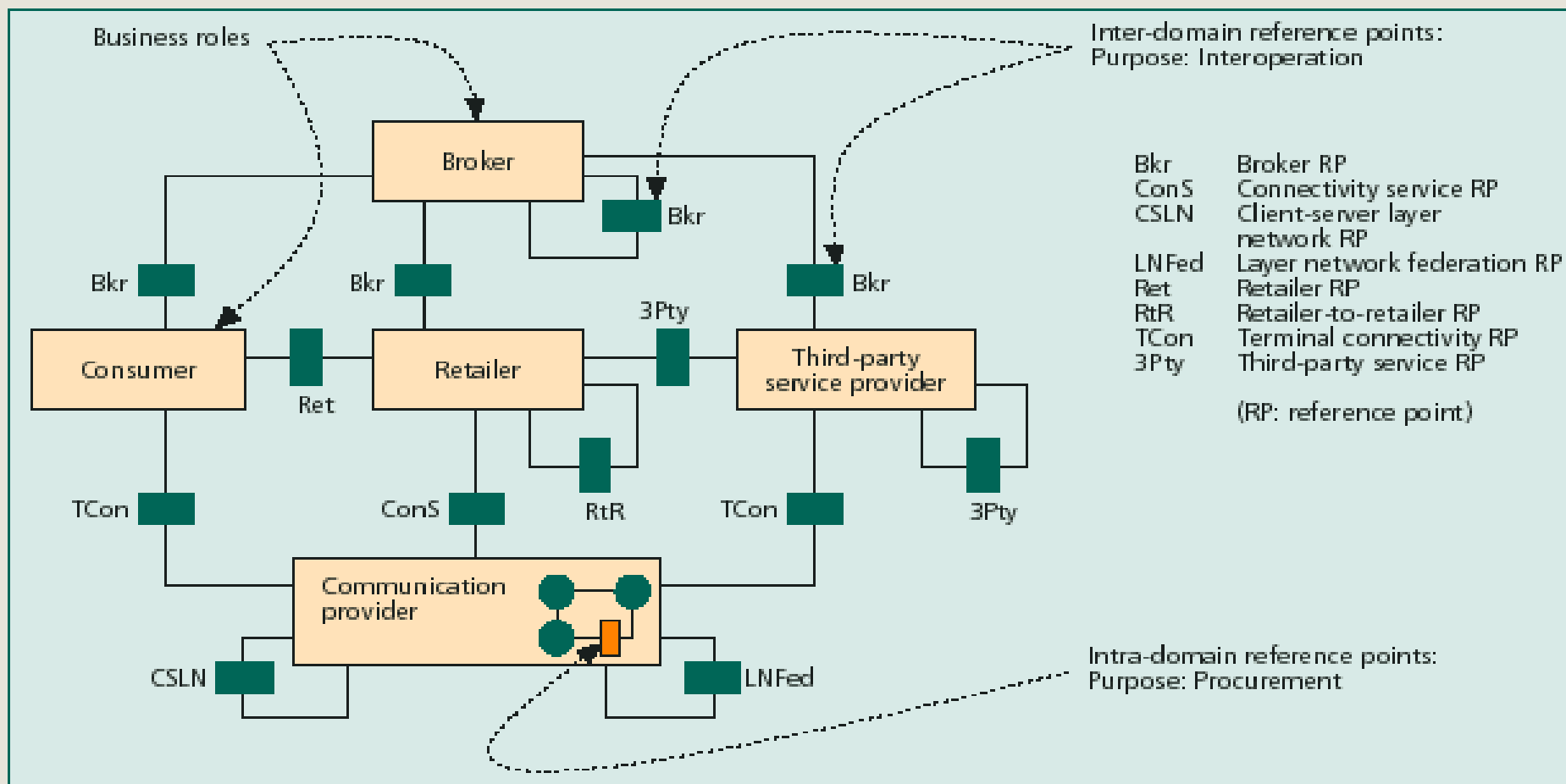

Note: Taken from IEEE Communications Surveys & Tutorials (Reference [x])

TINA: Fundamental principles

Roles

- **Consumer**
 - End-user: Actual user of the service
 - Subscriber: Entity having the business agreement for service usage
- **Retailer**
 - One stop shop
 - Entity which provides the services and which has the business agreement with the subscriber
 - Can provide own services or services subcontracted from third parties
- **Third party service provider**
 - Has business agreement with retailer and no direct business agreement with subscribers
- **Communication/connectivity provider:** “Pipe” provider
- **Broker:** Ensure fair information distribution to all parties

TINA: Fundamental concepts

Service life cycle

- Construction
- Deployment
- Usage
- Withdrawal

Session

- Generalization of the call model concept
- Access session:
 - Activities involving consumer and retailer for selecting, and initiating the use of a service (e.g. subscription, authentication)
- Service session
 - Activities involving consumers and retailer for the actual usage of the service – Keep track of the parties involved in the usage of a service and the connectivity between them (e.g. feature interactions)
- Communication session
 - Activities involving the actual usage of network resources (e.g. QoS)

TINA: Service Architecture

- 1. Support for a wide range of services**
- 2. Rapid service creation and deployment**
- 3. Tailored services**
- 4. Independent evolution of network and service infrastructure**
- 5. Support for multiparty environment**
- 6. Service manageability**
- 7. Universal access**
- 8. Inter-working with legacy**

TINA: Service Architecture

Architecture made of:

- Computational objects accessible via CORBA interfaces
- No protocol

Computational objects in the consumer domain:

- Provider agent (PA): Proxy through which the retailer makes service offer to the consumer
- Service session user application part (ssUAP): Service control interface in the terminal

TINA: Retrospective ...

A seminal service architecture

- Many sound concepts (e.g. service life cycle) and principles (e.g. separation of concerns) widely re-used
- A sound business model widely re-used

But, a commercial failure

- Lots of prototypes and trials, but very very few commercial deployment due to a wide range of factors
 - Too far ahead its time
 - Complexity
 - Too high level of ambition (e.g scope encompasses everything from networking to service engineering)
 - Too little weight to other important technological developments (I.e. Internet)
 - Too little consideration to installed basis

To probe further ...

1. On circuit-switched telephony

A. Tanenbaum, Computer Networks, 4th edition, Prentice Hall 2003 (Chapter 2.5 – The public switched telephone system network)

A. R. Moderassi and R. Skoog, Signaling System No7: A Tutorial, IEEE Communications Magazine, July 1990, available at:<http://www.comsoc.org/livepubs/surveys/public/4q98issue/reprint4q.html>

2. On intelligent networks

R. Glitho and Th. Magedanz, guest editors, Intelligent Networks in the new Millennium, IEEE Communications Magazine, June 2000 Vol.38 No6

3. On WAP

WAP 2.0 Technical white paper, <http://www.wapforum.org>

4. On TINA

H. Berndt, T. Hamada, and, P. Graubmann TINA: Its Achievements and its Future Directions, IEEE Communication & Surveys, 1Q 2000,